



GOLF IRRIGATION PRODUCTS



INTERNATIONAL MARKETS





Learn more at
Toro.com

TABLE OF CONTENTS



Overview

New Product Overview	3
Golf Sprinklers Overview	4
Field Controls Overview	6
Control System Overview	9
Turf Guard®	10
Irrigation Services	11



Control Systems Field Controllers

CONTROLLERS	12
Control Systems and Field Controllers	13
Lynx® Central Control System	14
Turf Guard® Wireless Soil Monitoring System	17
Control System Accessories	20
NSN® (National Support Network)	21
Lynx® GDC System	22
Lynx® GAC System	25
Lynx VP® Satellites	28
Lynx® VP®E Satellites	31
network LTC® Plus Upgrades	34
OSMAC® G3 Satellites	36
Watchdog® Weather Station	39



Sprinklers

SPRINKLERS	42
Sprinklers and Subsurface Drip	43
INFINITY® SERIES with SMART ACCESS®	45
INFINITY® Series Golf Rotors INF35-6/INF55-6	48
INFINITY® Series Golf Rotors INF35/INF55	53
IINFINITY® Series Golf Rotors INF34/INF54	58
FLEX800™ Series Golf Rotors FLX35-6/FLX55-6	63
FLEX800™ Series Golf Rotors FLX35/FLX55	68
FLEX800™ Series Golf Rotors FLX34/FLX54	73
FLEX800™ B Series Golf Rotors	78
FLEX800™ R Series Conversion Upgrades	85
T7 Series Rotors	94
690 Series Rotors	98
590GF Series Sprays	101
Precision™ Series Spray Nozzles	103
Precision™ Series Rotating Nozzles	108
Swing Joints	111
Sprinkler Tools	113



Valves

VALVES	114
Valves and Valve Boxes	115
220G Brass Series Valves	116
P220G Series Valves	119
TORO® Valve Boxes	122
TORO® Dry Boxes	125
470 Quick Coupler Valves	126



Resources

Technical Data	127
Wire Sizing	128
The Toro Limited Warranty	129





Learn more at
Toro.com

NEW PRODUCTS OVERVIEW



Golf Sprinklers



Field Controllers



Control Systems



Turf Guard®



Irrigation Services





GOLF SPRINKLERS OVERVIEW



Learn more at toroinfinity.com



INFINITY™ SERIES GOLF SPRINKLERS

Engineered for Today's Challenges. Designed for Tomorrow's Technologies.

The new INFINITY™ Series improves your course quality with less workload and most important, it keeps players playing. Calculate the money you'll save by cutting sprinkler maintenance from hours to minutes.



Smart Access®

Provides top accessibility to all critical components.



Future proof

The SMART ACCESS® compartment provides room to grow. Whatever the future holds, this sprinkler will be ready.



Protective enclosure

The protective enclosure isolates wire splices from the soil and potential shorts to ground. Provides access for system troubleshooting and repairs without digging!

SMART ACCESS compartment offers room for a decoder module, wire splices and all the room to grow in the future.



Go to INFINITY®





GOLF SPRINKLERS OVERVIEW

Toro FLEX800 R Series
Easily and economically upgrade
your existing Rain Bird® Eagle™ 900/1100
series sprinklers.



Learn more at
Toro.com



FLEX 800™ SERIES GOLF SPRINKLERS

Golf sprinklers with all the efficiency and proven performance features and benefits of the 800S and DT Series



LARGE NOZZLE SELECTION
From 6,0m to 30,5m (20' to 100') we've got you covered! Only Toro provides the flexibility to optimize your system for maximum uniformity.



NOZZLE BASE CLUTCHING
Simply pull up the riser and ratchet it to the precise position you want to water.

PART AND FULL CIRCLE MODELS
Align part circle quickly and easily or adjust watering locations to suit seasonal needs.

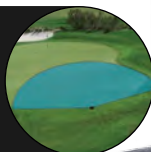

TRAJECTORY ADJUSTMENT
In 24-position Tru-Jectory or Dual Trajectory to help fight the wind, avoid obstacles or to reduce the radius.



Go to FLEX800



*Sturdy Plastic Pedestals
Available in Sand, Tree Bark or Green.*

SATELLITE CONTROL

Toro is the leading golf irrigation company in the world and provides an array of field control options.



Satellite-based systems are specified by many of the world's best designers. Satellite systems use controllers placed on each hole to operate a specified number of stations. These controllers are coordinated to work together with a central computer, but can also be programmed independently for grow-in and stand-alone operation.



Future upgrades can be accomplished with advanced satellite firmware, keeping you current with technology.



Satellite upgrade kits enable older Toro satellite units to be upgraded very cost effectively vs. a complete system change-out.



Hardwire, 2-way radio communication allow for easy installation and maintenance.



Custom pedestal colors enable satellites to blend into the natural surroundings.



FIELD CONTROLS OVERVIEW

While others have followed in our footsteps, Toro is the industry leader in advanced 2-wire systems, with the largest customer base and the largest systems in operation.

Learn more at Toro.com



1, 2 and 4 Station Modules

ADVANCED 2-WIRE CONTROL

Intelligent 2-wire modules can be installed inside the sprinklers or off-fairway.

2-wire systems are used in a vast array of golf courses around the World. Intelligent modules installed near or on the sprinklers replace these boxes. These modules are all connected to the central computer by a simple two-conductor cable. The elimination of the satellite boxes and the thousands of feet of wire simplifies the installation, improves the aesthetics and reduces cost.



Toro INFINITY® and FLEX800™ Series sprinkler models have an integrated 2-wire module option.



Allows for system expansion by tapping into the cable.



Best-in-class broadband lightning protection.



Real time diagnostics and voltage tests.



Vandal and flood resistant.



Continuous two-way communication.





Learn more at **Toro.com**



LYNX[®] SMART HUB



Optional Lynx Smart Hub combines the simplicity of a 2-wire system with the added security of a traditional satellite system.



Irrigation system can be segmented into manageable areas for simplified maintenance



Stores and runs a fully flow-managed irrigation schedule in the event the central computer is offline



Provides for in-field manual operation or troubleshooting



Creates a convenient point of connection for soil, flow and status sensors





CONTROL SYSTEM OVERVIEW



Learn more at torolynx.com

BETTER INFORMATION FOR BETTER DECISIONS WITH LYNX® CONTROL SYSTEM

Integrated Turf Guard® soil sensor helps you save water.

Integration with pump stations such as Grundfos, Flowtronex® PACE and Watertronics gives you complete information to support your irrigation decisions.

Simplified decision making with Dynamic Drilldown.



With NSN® Connect, Lynx is with you when and where you want.

Flexible and editable map simplifies irrigation control.

Maintaining optimal playability on your golf course, while best managing resources, requires the right combination of information and control.

The Toro Lynx Control System is your solution. It empowers you to take quick, accurate action to effectively control and manage your golf course by providing past, present and future course information from multiple sources into a single, intuitive interface.



Easy Set Up

Lynx® gives you a fast, accurate way to setup your system to put water exactly where you want it, and then allows you to make edits as your course conditions change.



Easy to Use

Lynx® has a distinct user interface that combines all essential data and intuitively presents the information you need at a glance.



Easy to Control

Lynx® empowers you to take quick, accurate action to effectively control and manage your golf course by providing past, present and future course information from multiple sources into a single, intuitive interface.



Support Available 24/7 with NSN®

Toro's exclusive National Support Network provides assistance from experienced service professionals. NSN Connect can be linked directly to the system.



Available Anywhere, Anytime.

Lynx® gives you the ability to access your irrigation controller from anywhere - simply and securely! Now also through our dedicated smartphone apps!

Click to visit Toro Lynx [Video Channel](#)



Go to Lynx®



TURF GUARD®



Learn more at
TurfGuard.com



TURF GUARD WIRELESS SOIL MONITORING SYSTEM

helps you improve your water efficiency, turf and soil.



Available fully integrated into the new Toro® Lynx® control system.



Monitors soil moisture, salinity, and temperature levels.



New easy to use SiteVision™ software provides superintendents with a wealth of data about soil conditions.



The in-ground sensors are easy to install, and have long lasting (3 years) batteries that can easily be replaced on-site.



Interactive report screens make it easier to access, analyze, print and download data.



Go to [Turf Guard®](http://TurfGuard.com)



Learn more at
Toro.com

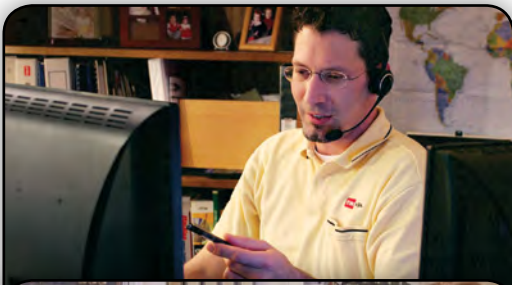

Toro Technical Support

Our technical support team is highly skilled at what they do. From helping superintendents, program controllers, to troubleshooting complex system issues with consultants, the support team provides years of irrigation experience that you can count on. For exceptional technical support, call 1-877-345-TORO.



Toro Controller Repair

Did you know that with Toro's Board Exchange Program you can get the replacement controller boards you need immediately? Through your distributor, Controller Repair provides controller boards ready for immediate board exchange to assure that controller downtime is minimal and your golf course and reputation stays protected. For immediate assistance call: 1-877-345-TORO.

(Visit Controller Repair website at www.toro.com/controller-repair)



Toro Distributor Support

Our distributors have been our partners for an average of 40 years (10 to 88 years) and we consider them an extension of us.



Toro Field Service

With some of the most knowledgeable and helpful field service staff in the industry, and our extensive training and support programs; Toro field service personnel are always there to assist—before, during, and well after a sale.



Toro Genuine Parts

From the smallest sprinkler part to complete control systems, Toro Service Parts support can deliver most replacement parts to our distributors within hours. In fact, Toro offers its customers the highest parts order completion rate in the industry: 98%!



Toro National Support Network (NSN)









A team of A+ certified technicians and licensed irrigators dedicated to the daily operations and maintenance of computerized central control systems for customers worldwide. (see page 19 for more information)





Learn more at **Toro.com**

CONTROLLERS

 Lynx®	 Turf Guard®	 Lynx GDC
 Lynx GAC <i>NEW</i>	 Lynx VP®	 Lynx VP®E
 Network LTC® Plus Upgrade Kits	 OSMAC® G3	 WatchDog Weather Station <i>NEW</i>





Lynx® Central Control System
[Page 14](#)



Turf Guard®
[Page 17](#)



Field Controller Comparison

Feature/Capability	Lynx GDC	Lynx GAC	Lynx VP®	Lynx VP®E	OSMAC® G3
Page	22	25	28	31	34
Maximum Station Per Controller	1600	1000	64	64	64
Maximum Simultaneously Operating Stations Per Controller/Gateway	200	32	32	16	16
Stand-alone Programs	10**	N/A	64	16	24*
Wireline Field Communication	Yes	Yes	Yes	Yes	No
Wireless Field Communication	Yes***	No	Yes	Yes	Yes
Upload Field Changes	No	No	Yes	Yes	No
Field Controller Alerts	Yes	No	Yes	Yes	No
Downloaded Programs	Yes***	No	Yes	Yes	No
Station Based Flow Management	Yes	Yes	Yes	Yes	Yes
Station Current Sensing	No	Yes	Yes	No	No
Station Runtimes In Seconds	No	Yes	Yes	Yes	Yes
Language Capacity	No	N/A	No	Yes	No

* Requires Smart OSMAC
 ** GDC 200 Stand-alone Gateway
 *** GDC Remote



LYNX® CENTRAL CONTROL SYSTEM

Superior course map editing and creation

Easily edit your course map. Create your own fully interactive map using a digital image of your course. **Program and control your irrigation activities right from the map**, with instant access to operation feedback from the rest of your irrigation system.



Learn more at torolynx.com

Unsurpassed integration with other system components

Lynx® offers unequalled integration with field hardware, pump stations, weather stations, electrical systems, smartphones and much more, including the Toro® Turf Guard® Wireless Soil Monitoring System.

Comprehensive reporting increases your productivity

Immediately address any irrigation concerns and avoid potential course damage . . . or just move on to other tasks when Lynx lets you know that things are running as planned.



Features & Benefits



Specifications



The Toro® Lynx® Control System

Developed specifically to help you address the unique challenges and changing priorities you face very day. With the Lynx System, you can now have all of your essential irrigation information readily available in one place, conveniently combined into a single, intuitive interface.

Click to watch Toro
Lynx Video





LYNX® CENTRAL CONTROL SYSTEM

Features & Benefits

1 Lynx Adds More Flexibility And More Control
Station Percent Adjust for duration allows you to set temporary adjustments that automatically returns to normal after a set number of days. The new Sequential Instant Program allows you to pick the order stations water automatically. GDC system diagnostics can now be selected by Hole or Area to make pin pointing a problem even easier, and you can now chose to have Lynx automatically upload station changes into the Watering Plan.

2 Simplified Decision Making With Dynamic Drilldown
Guides you to where you need to go. Follow the water drop in the Watering Plan to find stations, holes or entire areas that are disabled, on hold or otherwise not programmed to irrigate. Quickly find any stations in Course Report that did not operate as intended.

3 Flexible and Editable Map
Easily add, drag, drop and assign sprinklers, satellites, sensors and switches to their exact locations. You can effortlessly make edits as your field hardware changes. Fully supports CAD-generated maps.

4 Power Guard Helps Prevent Wasted Energy
Integration with a Flowtronex® pump station with PACE™ enables the exclusive Lynx Power Guard feature to track and control electricity usage of the system.

5 Lynx Mobile Apps Provide Remote Control
Lynx Mobile Apps enable you to control your irrigation system from your smart phone or tablet. Available for both iPhone®* and Android™* devices, Lynx Mobile Apps offer map and numeric based interfaces for manual irrigation, as well as an easy way to enter or edit GDC module addresses.



Dynamic drilldown
by area, for quick overview by area and by hole

Irrigation at a glance
The colour of the water drop tells you if it's going to irrigate or not.

Simple menu
All similar functions are organized into folders

Save the most important pages
All the daily functions can be one mouse-click away

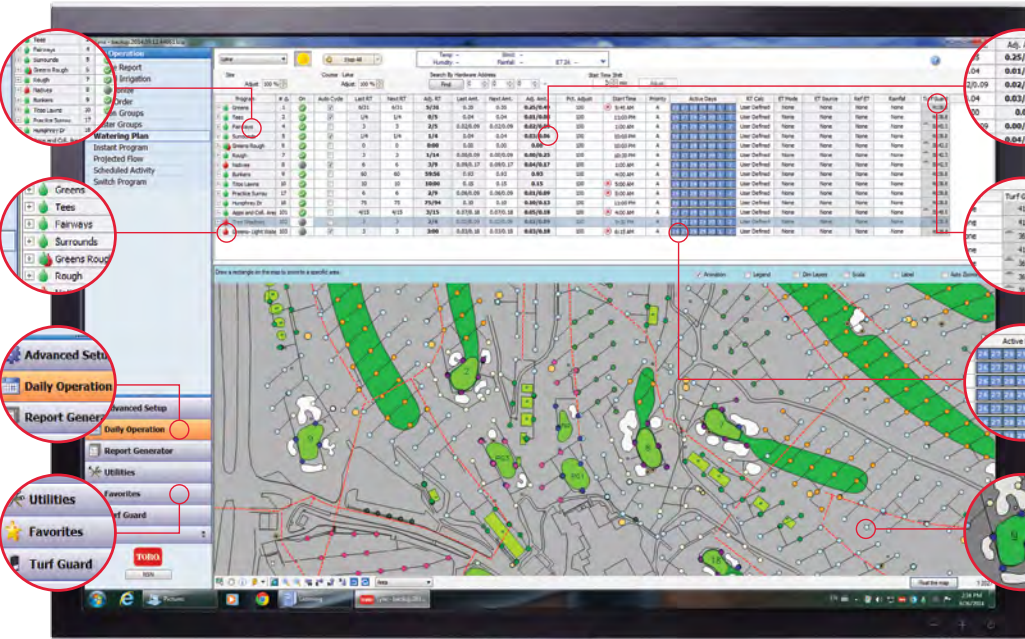

Decide how many inches/mm/minutes to water.

Intelligent irrigation with Turf Guard
Your Turf Guard sensors help you to decide when to irrigate and how much water to apply.

Decide which days of the week you are going to turn on sprinklers.

Easily edit your course map or create your own interactive map.

5 Lynx® Mobile Apps



Lynx Map



Lynx Handheld



Lynx Barcode



Lynx Mobile
Enables remote access and control from any mobile device connected to the Internet. Screens are specifically designed and optimized for smaller devices.



* iPhone and the Apple logo are registered trademarks of Apple, Inc. in the U.S. and other countries.

* Android and the Android logo are trademarks or registered trademarks of Google Inc.



LYNX® CENTRAL CONTROL SYSTEM



SPECIFICATIONS – Lynx® Levels Comparison

SYSTEM CAPACITY	Lynx CE	Lynx PE	Lynx SE
Satellites	500	500	500
Satellites Stations	32,000	1344	512
GDC Stations	6400	1000	500
Weather Stations	10	10	10
Pump Stations	10	3	2
Courses	3	2	1
Holes	84	56	28
Hydraulic Branches	1024	300	100
Sensor Inputs per Board	7	7	N/A
Sensor Input Board per Satellite	1	1	N/A
Sensor Input Board per System	40	40	N/A

HARDWARE SUPPORTED

OSMAC®	Yes	Yes	Yes
Lynx GDC	Yes	Yes	Yes
Lynx GAC	Yes	Yes	Yes
Lynx VP® /Lynx VPE	Yes	No	No

PROGRAMMING

Lynx VP Sensors	Yes	No	No
E-OSMAC Sensors	Yes	Yes	No
VP Current Sensing	Yes	No	No
VP Station Adjust Upload	Yes	No	No
Site Code Categories	7	3	No
Precip. Mgmt. Groups (PMG)	Yes	Yes	No
Max. Stations/Hole Control	Yes	Yes	No
Instant Program Creation	Yes	Yes	Yes
Program Priority	Yes	Yes	No
Pump Profiling	Yes	Yes	No
Station Group Multi-Manual	Yes	No	No
Master Group Multi-Manual	Yes	No	No
Pump Integration	Yes	Yes	Optional
Weather Station ET	Yes	Yes	Optional
ET Auto Calc. RT Method	Yes	Yes	Optional

**NSN® Connect
Remote access
so that you can
control irrigation
anytime,
anywhere.**

ADDITIONAL FEATURES

Runtimes:

- Runtimes are executed to the second rather than rounding to the whole minute, resulting in more precise irrigation and water savings (Lynx VP® /Lynx VPE & OSMAC® only)
- Control your irrigation by setting runtime minutes or application inches and let the system calculate the other. See exactly how much water you will apply and how long you will irrigate each area.
- Runtime synchronization with Lynx VP /Lynx VPE satellites prevents irrigation outages if the central goes offline.
- Integrated runtime display shows past and planned irrigation activity so you can easily determine what action to take.

Quick Start:

- With Quick Start, you create station, hardware and area associations, and control the definition of greens, tees, fairways and sprinklers based on their locations.
- A basic hydraulic tree is auto-generated for you during Quick Start.

Views and Reports:

- Course Report provides both real time and daily summaries of both scheduled and manual watering events.
- Area and Hole orientation allows you to control your irrigation system the same way you think about the course.
- Instant Program has simple check-box selection and Dynamic Drilldown to you can instantly create and personalize new irrigation programs
- Projected Flow View shows you areas that will be watered and how much will be applied.

Communication:

- Current-sensing capabilities notify you of wire cuts and sprinklers unintentionally turned off (Lynx VP /Lynx VPE only).
- Constant communication with Lynx VP /Lynx VPE satellites lets you take action if a power outage threatens irrigation.
- Toro GDC communication and solenoid diagnostics help identify shorts, low voltage and other issues.
- Weather station integration and Hand-held Remote Interface support are included as standard features

Operating System:

- Windows 7

Warranty

- Two years



Specifying Information—Lynx

LX-0X-1-XX-M					
Type	Computer Hardware	Service	Level	Field Hardware	Optional
LX	0X	1	X	X	M
LX—Lynx	0—Budget Computer 1—Standard Computer	1—1-year NSN (Standard)	2—SE 3—PE 4—CE	1—OSMAC / E-Series OSMAC 3—Lynx VPE 7—Lynx VP 8—Lynx GDC 9—Lynx GAC	M—Lynx GDC Remote Gateway and FIU
Example: When ordering a Lynx PE Central with a standard computer and one year of NSN using Lynx VPE field hardware, you would order: LX-01-1-33					

* Available only in PE and CE levels

** Lynx VP and VPE models only



TURF GUARD® WIRELESS SOIL MONITORING SYSTEM



Learn more at
Toro.com



Get the essential soil information you need, when you need it.

Stay up to date on your current soil conditions no matter where you are. Get the information you need to make important decisions in real time. Turf Guard sensors instantly track soil moisture, salinity, and temperature, saving you time. Repeaters mount easily inside all Toro® Lynx VP®, Lynx VP®E, Network LTC® Plus and E-OSMAC® satellite pedestals.

Features & Benefits



Specifications



Integrated Turf Guard® Soil Sensor Information helps you determine when to irrigate and how much. Which helps you save water.



TURF GUARD® WIRELESS SOIL MONITORING SYSTEM

Features & Benefits

Reduce Water Usage and Improve Playability

Monitor moisture levels and adjust irrigation without risking turf quality. Promote root growth by avoiding over watering. Detect dry areas before they impact the turf's health.

2 100% Wireless Network

No wires between the repeaters and the sensors, or the sensor and the probes means that sensors can be installed anywhere on the course without disrupting play. Install sensors without having to trench or pull wires.

3 Take the Guesswork out of Managing Salinity

Track salt build-up and schedule flushing as needed. Get positive confirmation that your flushing reduced soil salts. Know when and how much water to flush with.

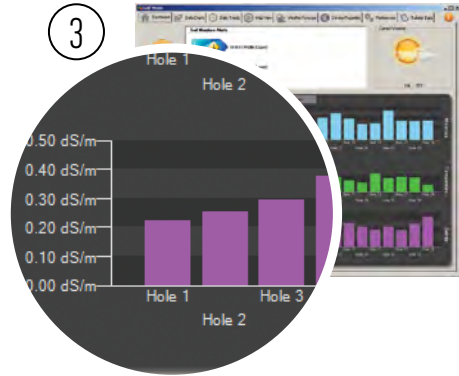

Web-based or Stand-alone Interface

Graphical course overview displays sensor data at-a-glance. Plus with Toro Lynx® Control System integration you can check course moisture, salinity and temperature readings right from your irrigation control software.



TURF GUARD® WIRELESS SOIL MONITORING SYSTEM



How it works:



- Three to five sensors buried in each green at critical root zone levels
- Additional sensors buried in fairways, tee boxes and planters
- Above-ground radiorepeaters installed on or in existing irrigation pedestals
- Wireless MESH networking links all sensors to central control system.
- Moisture, Temperature and Salinity readings displayed in your office

SPECIFICATIONS

Operational

- Two distinct depths in the soil profile – critical root zone level and a second 127mm (5") lower. Independent measurements from each depth.
- MESH routing technology offers complete coverage even in remote canyon courses.
- Repeater mounts in most Toro irrigation satellite pedestals. An external repeater is available for other models including non-Toro pedestals.
- Supports up to 500 sensors per course
- Expected sensor battery life of 3 years, field replaceable.
- Sensor reading sent every 5 minutes.
- Automatic network configuration and failure recovery.
- Plots trends and compares historical and current readings.
- Lynx® Control System integration

Electrical

Input Power:

- Repeater: <0,02A @ 6 VDC
- Base Station: <0,1A @ 120 VAC, 50/60 Hz

Sensor dimensions:

- Body: 5,1 x 7,6 x 12,7cm (2" x 3" x 5")
- Spikes: 6,4 x 0,5cm (2.5" x 0.1875")
- Installation Hole Diameter: 10,8cm (4.25")

Sensor temperature:

- Operating: 0°C to 60°C (32°F to 140°F)
- Storage: -30°C to 82°C (-22°F to 180°F)

Sensing:

- 0,1°F Temperature resolution
- 0,1 % Volumetric soil moisture content resolution
- 0,1 dS/m Soil conductivity resolution (Salinity)

Communication:

- Repeater Range: 610m (2,000') line-of-sight
- Buried Sensor Range: 152m (500') line-of-sight
- Additional licensing not required

Warranty

- Two years

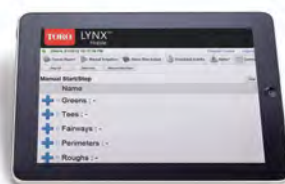
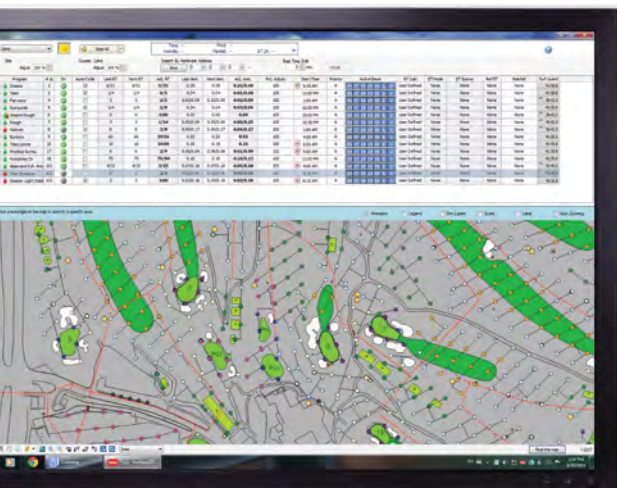

Specifying Information—Turf Guard

TG-XX-XXX-XX		
Model	Description	Communication
TG	XX-XXX	XX
TG-Turf Guard	S2-R-Sensor, Replaceable Battery B-Base Station R-EXT-Repeater, External R-INT-Repeater, Internal PS-Power Supply	AU-915.5 to 927.5 MHz Band EX-900 MHz ISM Band EU-869 MHz ISM Band

Note: Not available in all locations, please check with your Toro representative for availability.

Radio Interface Unit (RIU)

The Toro® Radio Interface Unit combines the functions of the OSMAC® Base Station and Hand-held Remote Interface (HHRI) in a single unit. Available in a dual radio configuration that performs both Base Station and HHRI functions, a single radio configuration that's programmable for either function, and a radio-less configuration that's programmable for either function and utilizes a user-supplied external radio for added flexibility.

Features & Benefits

- Provides control of your system while you're on-the-go
- Provides both hand-held control and central-to-satellite communication
- Designed to operate continuously, 24/7
- Interfaces with your Lynx® or SitePro® central without the burden of recurring network costs
- Tailored to fit your application with programmable selections for: OSMAC Base Station and hand-held remote interface modes, independent transmit/receive UHF frequencies, independent transmit/receive private line settings (CTCSS) and transmit power.

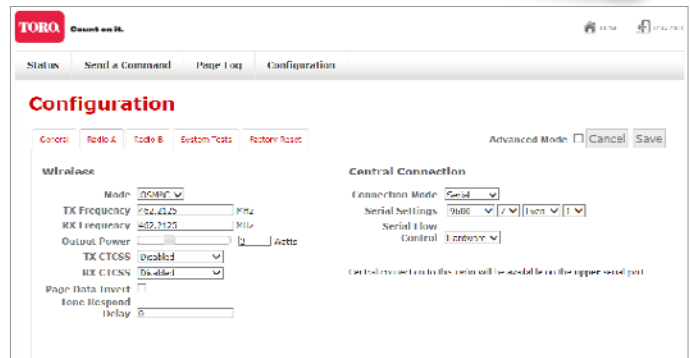

Radio Interface Unit (RIU) Graphical User Interface.

Specifying Information—Radio Interface Unit (RIU)

Model	Description
RIU-00	Radio Interface Unit – External Radio

Note: FCC license required.

Network Radio-Link and FIU with Radio

Network Radio-Link offers you the flexibility to design your irrigation system unconfined by the limitations of distance or terrain. Oversized acreage and natural barriers are not a problem for Network Radio-Link. Communicating where wires can't run, it's the bridge between non-contiguous wire line systems and much more.

Features & Benefits

- Wireless communication to Network satellites
- Network Radio-Link kits for upgrades
- True 2-way communication
- Multi-port field interface allows one radio to be shared among many satellites
- Easy satellite installation
- Compatible with Network LTC Plus, Lynx VP, Lynx VPE and Lynx GDC with Remote Gateway



Specifying Information—Field Interface Unit (FIU)

Model No.	Description
FIU-2011	Field Interface Unit with 1 Wire Line and 1 Radio Line, Radio Not Included
FIU-2011R	Field Interface Unit with 1 Wire Line and 1 Radio Line, Radio Included
FIU-2021	Field Interface Unit with 2 Wire Lines and 1 Radio Line, Radio Not Included
FIU-2021R	Field Interface Unit with 2 Wire Lines and 1 Radio Line, Radio Included

Note: FCC license required.



NSN® (NATIONAL SUPPORT NETWORK)

- WE'RE ALWAYS HERE FOR YOU!



Learn more at
Toro.com



National Support Network, Toro NSN®

Before, during and after the purchase of your Toro central control system, we pledge to support all of your needs with our National Support Network, Toro NSN®. From small system upgrades to large-scale golf applications, our knowledgeable staff, including bilingual representatives, is available to assist you over the phone 24/7, every day of the year. Our technicians can link directly to your system's computer to perform remote diagnostic checks and offer expert advice. If necessary, we can send you a replacement computer within 24 hours - during the work week (delivery times may vary, depending on ship-to location). Support subscriptions to Toro NSN are included with the purchase of a Toro central control system and can be renewed for extended periods after this initial subscription. NSN Connect provides remote access and our latest offering, NSN Connect Plus allows remote monitoring of your system. The NSN Customer Portal is your one-stop-shop for anything and everything dealing with your NSN relationship.

Features

- Remote access so that you can control Irrigation anytime, anywhere
- Easy access from your Apple or Windows mobile device
- Ability to easily transfer files
- Ability to print remote documents from a remote location
- Remote access activity logs and other

NSN® Connect Plus for Lynx Features

Adds remote hardware and software monitoring to NSN Connect

- Proactive support and computer hardware replacement from NSN

NSN® Connect Plus for Lynx

Specifications

- Platform – Toro® Lynx control system
- Operating System – Windows 7 (64-bit)
- User Configuration:
 - Ability to enable / disable specific monitors
 - Ability to have alerts sent to different recipients for different monitors
- Monitors
- Toro Lynx Control System Software
- Computer Hardware
- High speed Internet access required at the irrigation computer



Features & Benefits



Specifications



The Lynx GDC System

The Lynx GDC System uses innovative technology to provide an irrigation solution to customers who want a safe, reliable and energy efficient system. Using a two-wire path to communicate to buried control units, the system eliminates the costs associated with traditional valve wire bundles and provides a solution that is vandal resistant, easy to install and easy to expand.

Features & Benefits

- ① **Lower Costs With Flexible Configurations**
GDC Systems can be configured with the modules located in valve boxes outside of the playing area for easy access and lower cost, or with the modules integrated with the sprinkler to reduce wire and splices.
- ② **Lightning Protection With Integrated Surge Protection (ISP)**
ISP 2-wire modules are rated at 20 KV surge protection—the highest in the industry. In some of the most active lightning areas of the world, the GDC provides rock-solid performance.

- ③ **Easily Expandable Up To 9000 Stations**
Whether you have 100, 800 or 9000 stations, the GDC system will meet your needs and can be expanded by simply adding modules.
- ④ **Lynx Smart Hub**
Optional Lynx Smart Hub combines the simplicity of a 2-wire system with added security, programmability and sensing.

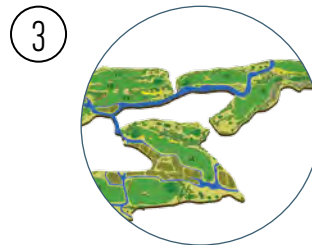

Diagnostics
Built-in diagnostics automatically let you know if there are any problems. The wire path check quickly confirms that the whole system is operational.

Integrated Sprinkler
Toro valve-in-head sprinkler models have an integrated 2-wire module option.

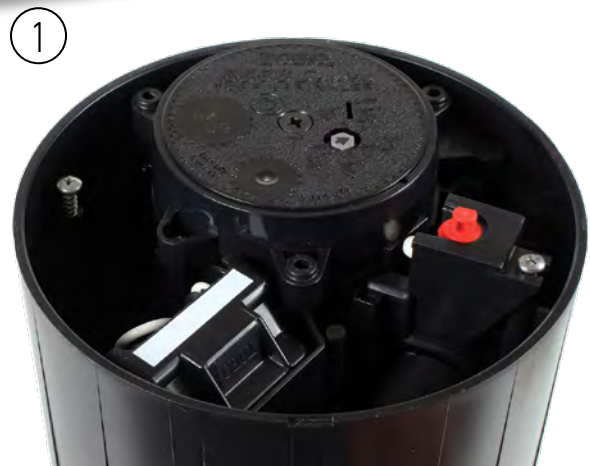

LYNX GDC SYSTEM



Off Fairway Configuration

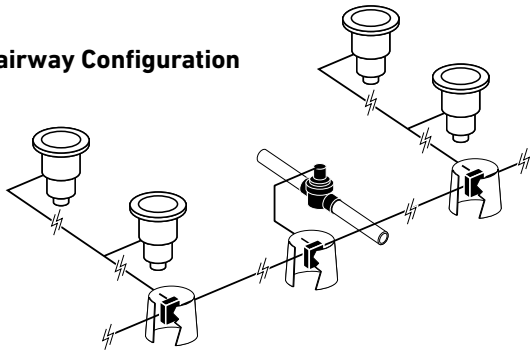

Integrated Configuration

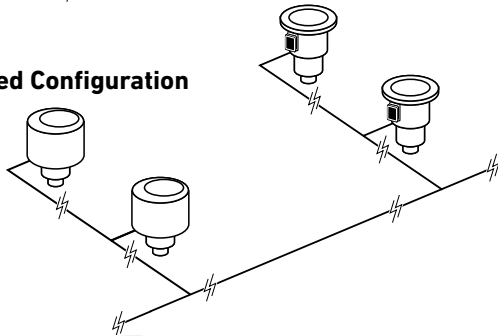

Standard



Lynx Smart Hub

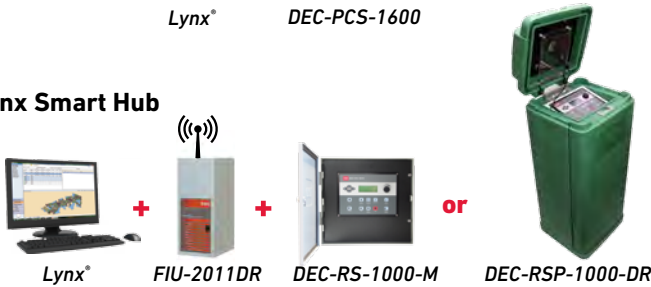

SPECIFICATIONS

Operational

- Lynx Central:
 - Mapping capabilities
 - Remote hand-held operation
 - Weather station integration
 - Pump station integration
- Enhanced diagnostics:
 - Communication
 - Electrical shorts/opens
 - Solenoid check
- No holding power required to operate stations
- Decoder identification is a unique 5-character address
- Standalone option (GDC200)

Installation

- Maximum number of wire paths:
 - 4 per gateway
- Maximum number of gateways:
 - 4 per system (standard)
 - 20 per system Lynx Smart Hub
- Maximum number of decoders per wire path:
 - 250
- Maximum stations per gateway:
 - 1000 integrated (Standard)
 - 1600 off fairway (Standard)
 - 1000 Lynx Smart Hub
- Maximum stations per system:
 - 4000 integrated (Standard)
 - 6400 off fairway (Standard)
 - 9000 Lynx Smart Hub
- Simultaneous stations per output board:
 - 100
- Maximum distance from central to module (using 14 gauge wire): 4 Kilometers (2.6 miles)
- Maximum distance from module to sprinkler (using 14 gauge wire): 121.9m (400 ft.)
- Solenoids per output: 2 DCLS-P
- Stations per module: 1, 2 or 4

Electrical

- Input power:
 - 88-264 V ac, 50/60 Hz
- Output Power:
 - Output voltage: 40 V ac max
 - Output power: 75 VA max
 - Class 2, SELV
- ISP 2-wire modules are rated at 20 KV surge protection
- 2-Wire modules wiring: 14 awg

Temperature

- Operating temperature: 0°C to 60°C (32°F to 140°F)
- Storage temperature: -30°C to 100°C (-22°F to 212°F)

Warranty

- Two years

Specifying Information—2-Wire modules DEC-RSP-1000M or DEC-RSP-1000-DR

DEC-ISP-X	
Type	Configuration
DEC-ISP	XX
DEC-ISP—Module*	1—1-station 2—2-station 4—4-station

Example: A 2-station GDC Module would be specified as: DEC-ISP-2

*Refer to sprinkler pages for specifying information on Sprinkler 2-wire Modules

Specifying Information—Gateway or Lynx Smart Hub

DEC-SA-200			
Type	Communication	Cabinet	Sta. Count
DEC—Decoder	XXX	X	200
	SA—Stand-alone PCS—Central RS—Lynx Smart Hub	blank P B T	WM Metal 200—200 Stations Green Plastic Pedestal 1600—1600 Stations, Standard Brown Plastic Pedestal 1000-M—1000 Stations, Lynx Smart Hub, Wired Tan Plastic Pedestal 1000-DR—1000 Stations, Lynx Smart Hub, Radio

*1000-M & 1000-DR only



LYNX® GAC SYSTEM

NEW



Learn more at **Toro.com**

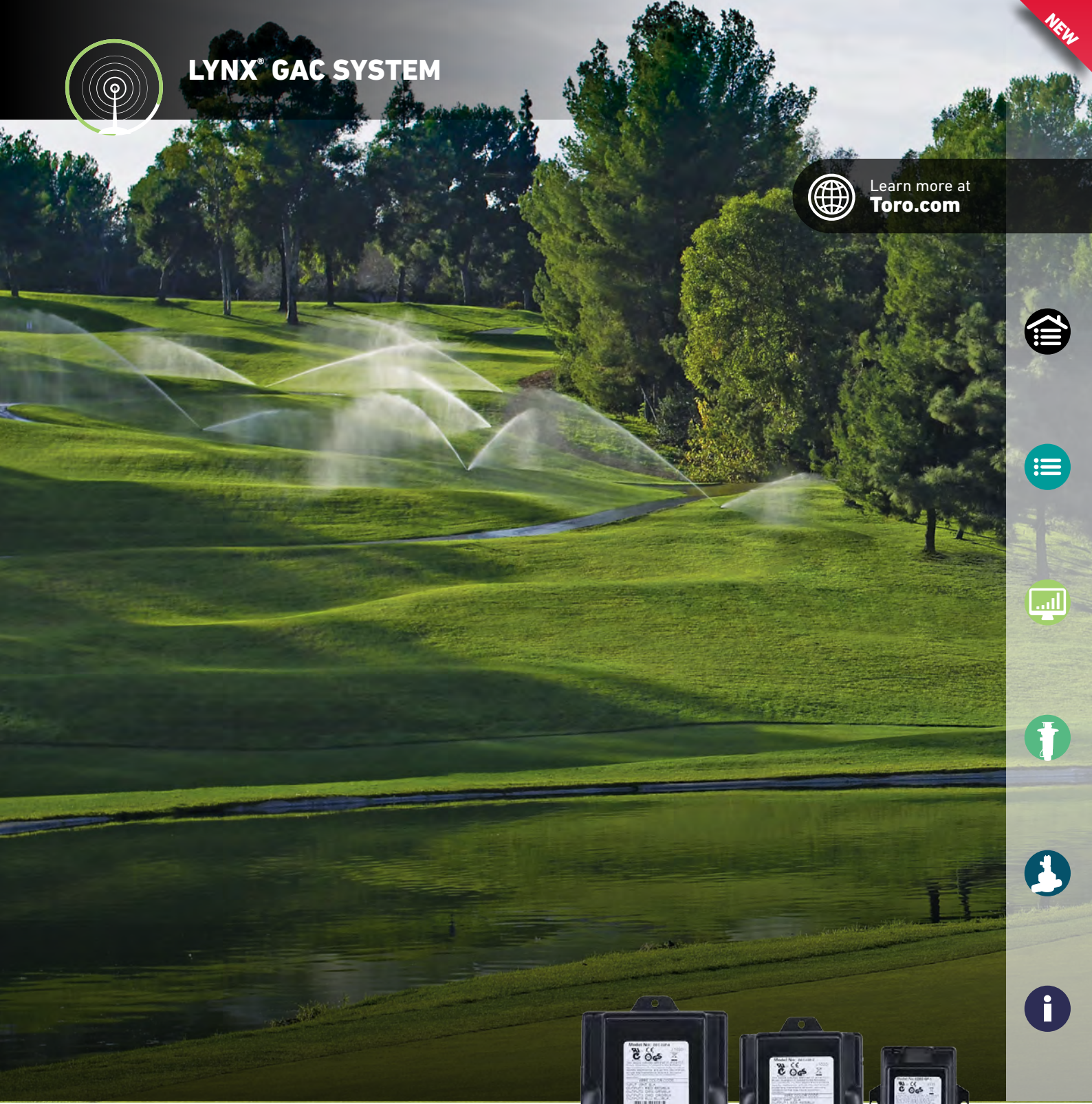

Features & Benefits



Specifications



Lyn GAC Modules

The Lynx® GAC System

The Lynx upgrade system uses modern electronic technology to enable users of older decoder control systems to upgrade to a modern central with new field hardware. New features like remote control from your phone, moisture sensing and sophisticated diagnostics are now available without replacing your entire irrigation system.



LYNX® GAC SYSTEM

Features & Benefits

- 1 **Upgrade Your Old System**
Works with your existing sprinklers and wiring - just replace your field decoders and the central control. All the advantages of Lynx® are available to you.
- 2 **Use Your Resources Efficiently**
Lynx® allows saving of water and electricity up to 35% of your current costs.
- 3 **No Digging Required, Leave Them In The Ground**
With Lynx® GAC you can keep your system in the ground with no digging. You only need to change the decoder modules and the central.
- 4 **Make Your Investment Last Longer**
With Lynx® GAC your irrigation system just got a life extension. Your system will be fit for the future for a fraction of the cost of a new irrigation system.

Click to watch Toro
Lynx Video



Full screen: right mouse click and choose full screen multimedia



LYNX® GAC SYSTEM

Benefits for Users of Older CDS Systems:

- Two-way communication
- More precise run time (+/- 1 second)
- Enhanced diagnostics - rapid communication check, voltage, and amperage, cable length
- 20KV lightning protection
- Lynx Central Control (all the benefits, apps, NSN)
- 1-station fits in Toro INFINITY® Series golf sprinklers with Smart Access®

Feature	TORO GAC	Toro CDS
Stations Per Wire Path	500	112
Devices Per Wire Path	125	112
Outputs	1,2,4	1,2,3,4
Maximum 2.1 or 2.5mm ² AWG Wire Path Length	2100 m	1600 m
Simultaneous Stations with 2100 m of 2.1 or 2.5mm ² AWG Cable	16	2
Distance from Decoder Module to Solenoid	175 m 1.5mm ² cable	363 m 1.5mm ² cable
Solenoids Per Output	2	2
Surge Protection	20 KV	6-8 KV
Wire Paths Per Gateway	2	4
Solenoid Characteristics 24VAC, 60 Hz	400mA inrush 250mA holding	400mA inrush 200mA holding
Holding Current	40mA	300mA
Two-Way Feedback from Decoder Module	Volts Amps Distance	No

SPECIFICATIONS

Operational

Enhanced diagnostics

- Communication
- Electrical shorts/opens
- Voltage
- Amperage

Module addresses are factory programmed

Low holding current

Installation

GAC gateways are available in standard and expansion configuration. Each standard gateway can connect with 2-wire paths with maximum 125 decoders each. An expansion gateway can connect with a standard gateway and includes only daughter boards. The capacity is the same as the standard gateway, but the cost is lower.

Maximum number of wire paths

- 2 per gateway

Maximum number of gateways

- 4 standard, 4 expansion

Electrical

- Input voltage: 100-240 VAC, 50/60 Hz
- Input current: 1.6A/1.0A (115/230)
- Output voltage: 40VAC max
- Output power: 75VA max
- Class 2, SELV
- Decoders and gateways have 20KV surge protection

Temperature

- Operating temperature: 0°C to 60°C (32F to 140°F)
- Storage temperature: -30°C to 60°C (-22F to 140°F)

Warranty

- Two years



Specifying Information—GAC Module

DAC-ISP-X	
Type	Station Count
DAC-ISP	X
DAC-ISP-Module	1-1 Station, 2-2 Station, 4-4 Station

Specifying Information—Gateway

DAC-XXX-XXXX		
Type	Communication	Station Count
DAC	XXX	XXXX
DAC	PCS – Central	1000 1000-E



Features & Benefits



Specifications



The Lynx VP® Satellite from Toro®

The Lynx VP® satellite from Toro® combines modular flexibility, ease of use and increased control in a single controller. With individual station runtimes programmed to the second and station-based flow management, the Lynx VP provides the most water efficient capabilities for irrigating.



LYNX VP® SATELLITES

Features & Benefits

- 1 **Station Based Flow Management**
Reduces nighttime water window and optimizes pump capacity. Central irrigation programs (greens, tees, etc.) are available from the satellite faceplate for manual watering and field adjustments.
- 2 **Quick Sync**
Variable Length (VL) protocol synchronizes scheduled irrigation between Lynx and Lynx VP satellites in minutes.

- 3 **Current Sensing Provides Protection**
Monitors each station output for proper amperage draw with user defined thresholds. Under and over current alarm notification protects against electrical shorts, wire cuts, etc.
- 4 **Runtime In Seconds For More Precise Watering**
Station runtimes are executed to the second. This prevents individual stations from over or under watering by up to 25% compared to systems that operate only in whole minutes.

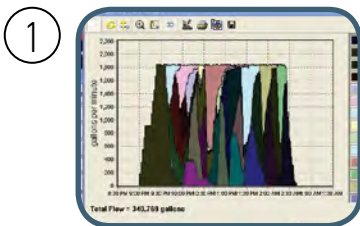
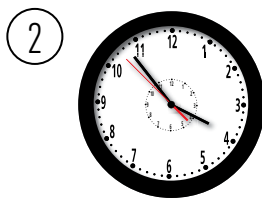
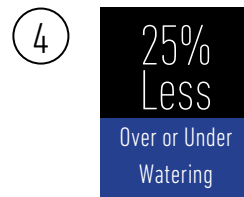
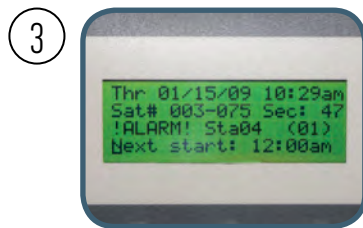

Intuitive User Interface With backlit display for better low-light viewing. Station range entry makes establishing irrigation routines easier. DVD type controls for Start, Pause/Resume and Stop.



LYNX VP® SATELLITES



Upgrade Kit – Network LTC® Plus to Lynx VP
 Upgrade kits include a faceplate, power distribution board, and interface cable. Full installation can be completed in minutes per controller.
 For more information see [p. 34](#)

SPECIFICATIONS

Operational

- Operates as a stand-alone controller, or under the management of a central computer
- Supports wireline or radio communications
- Supports hybrid communication (wireline & radio)
- 64 irrigation programs
- Basic, Advanced and Grow-in programs
- Percent adjust from 1% to 900%
- Each output can be defined as an irrigation station or general application switch
- Non-volatile memory retains program information and satellite settings during power-off conditions. Battery back-up retains the date and time.
- 16-64 stations in 8-station increments – individual station control and the ability to run up to 32 stations simultaneously

Electrical

Input Power:

- 108 V ac to 132 V ac, 60 Hz
- 0,20 amps (no load) 115 V ac
- 1,20 amps (max load) 115 V ac
- 216 V ac to 264 V ac, 50 Hz
- 0,10 amps (no load) 230 V ac
- 0,60 amps (max load) 230 V ac

Output Power:

- 24 V ac
- 3,0 amps (max total load)
- UL Listed

Additional Specifications

- Operating temperature: -10°C to 60°C (15°F to 140°F)
- Storage temperature: -30°C to 65°C (-22°F to 149°F)
- Humidity: 0% to 95% RH (non-condensing)

Dimensions

- Plastic Cabinet: 43,2cm W x 101,6cm H x 40,6cm D (17" W x 40" H x 16" D)
- Metal Cabinet: 33,0cm W x 91,4cm H x 33,0cm D (13" W x 36" H x 13" D)

Warranty

- Two years



Specifying Information—Lynx VP Satellites

201-XXX6XX					
Description	Configuration	Cabinet	Output	Comm.	Options
201	XX	X	6	X	X
201—Lynx VP Satellite	16—16 Stations 24—24 Stations 32—32 Stations 40—40 Stations 48—48 Stations 56—56 Stations 64—64 Stations	P—Plastic, Green T—Desert Sand B—Tree Bark	6—24 VAC Electric	M—2-Way Wire Modem R—UHF Radio	3—Large-capacity Terminal Block & Switches 4—Large-capacity Terminal Block w/Add'l Surge & Switches
Example: When ordering a 24-station, 2-Way Wire Modem VP Satellite in a plastic cabinet with large-capacity terminal block and switches, you would specify: 201-24P6M3					

Radio option not available in all locations, please check with your Toro representative for availability.

Specifying Information—Network LTC Plus Upgrade Kit

118-0038
Kit Contains
Lynx VP Faceplate, Network LTC Plus To Lynx VP Power Distribution Board, Cable And Hardware



Features & Benefits



Specifications



The Lynx VPE Satellite

The Lynx VPE Satellite combines modular flexibility, ease of use and increased control in a single controller. Available in configurations from 16 to 64 stations and in eight-station increments to meet your needs. Optional station switches and surge protection provide simple operation and added security. Lynx VPE can also be operated in 7 different languages.

Features & Benefits

- 1 Multi-Language Display**
 Display supports 7 languages: Chinese, English, French, Italian, Japanese, Korean and Spanish.
- 2 Intuitive User Interface**
 Easy to use interface with backlit display for better low-light viewing. Large 128 x 64 LCS screen display menu.
- 3 Station Based Flow Management**
 Reduces nighttime water window and optimizes pump efficiency. Central irrigation programs (greens, tees, etc.) are available from the satellite faceplate for manual watering and field adjustments.
- 4 Two Way Communication With Improved Download Time**
 Upload changes and programs made in the field automatically. Saves programs in case of communications loss. Variable length (VL) communication reduces download time by up to 80% from previous versions.
- 5 Modularity Provides Flexibility**
 16-64 stations in 8-station increments – 16 programs – individual station control and you can run up to 16 stations simultaneously.

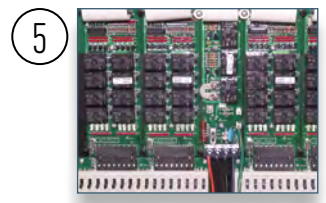
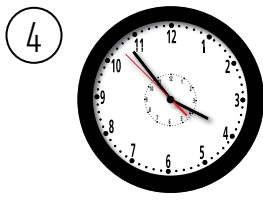
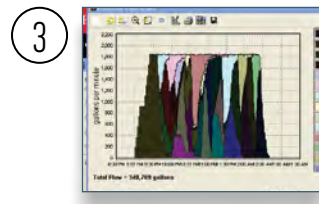
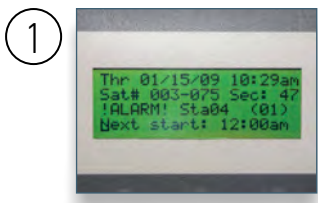

LYNX VP^E SATELLITES



SPECIFICATIONS

Operational

- Optional output switches and surge protection
- Sturdy plastic pedestal
- Supports wireline or radio communications
- Supports hybrid communication (wireline and radio) for increased flexibility and cost effectiveness.
- 16 irrigation programs
- Pause, Resume and Stop functions
- Supports run times from 1 second to 23:59:59
- Percent adjust from 1% to 900% (Station, Program, Satellite)
- Each output can be defined as an irrigation station or general application switch
- Non-volatile memory retains program information and satellite settings during power-off conditions. Battery back-up retains the satellite date and time

Electrical

Input Power:

- 108 V ac to 132 V ac, 60 Hz
 - 0,20 amps (no load) 115 V ac
 - 1,20 amps (max load) 115 V ac
- 216 V ac to 264 V ac, 50 Hz
 - 0,10 amps (no load) 230 V ac
 - 0,60 amps (max load) 230 V ac

Output Power:

- 24 V ac
- 3,0 amps (max total load)
- UL Listed

Additional Specifications

- Operating temperature: -10°C to 60°C (15°F to 140°F)
- Storage temperature: -30°C to 65°C (-22°F to 149°F)
- Humidity: 0% to 95% RH (non-condensing)

Dimensions

- Plastic Cabinet: 43,2cm W x 101,6cm H x 40,6cm D (17" W x 40" H x 16" D)

Warranty

- Two years



Specifying Information—Lynx VP^E Satellites

10X-XXX6XX						
Description	Configuration		Cabinet	Output	Comm.	Options
10X	XX		X	6	X	X
100—Lynx VP ^E Satellite (115/230 VAC Input)	16—16 Stations	24—24 Stations	P—Plastic, Green	6—24 VAC	M—2-Way Wire Modem R—UHF Radio	3—Large-capacity Terminal Block & Switches 4—Large-capacity Terminal Block w/Add'l Surge & Switches
109—Lynx VP ^E Satellite (100/200 VAC Input)	32—32 Stations	40—40 Stations	T—Desert Sand			
	48—48 Stations	56—56 Stations	B—Tree Bark			
	64—64 Stations					
Example: When ordering a 24-station, 2-way wire VP ^E Satellite in a plastic cabinet with large-capacity terminal block, additional surge and switches, you would specify: 100-24P6M4						

Radio option not available in all locations, please check with your Toro representative for availability.

Specifying Information—Network LTC Plus Upgrade Kit

102-9740
Kit Contains
Lynx VP ^E Faceplate, Network LTC Plus To Lynx VP ^E Power Distribution Board, Cable And Hardware



NETWORK LTC® PLUS UPGRADES



Learn more at
Toro.com



Specifications



Network LTC® Plus to Lynx VP/VPE

Are you planning to upgrade all your field control satellites to Lynx VP/VPE or do you just want to change some of them to make you ready for Lynx in the future? We have the solution for you, if you choose one of these packages:

1. Network LTC Plus® to Lynx VP/ VPE upgrade kit
2. Network LTC Plus® to LTC Pro upgrade kit



Network LTC® Plus to Lynx VP/VPE

Do you want to upgrade to Lynx without changing all the satellites? These packages can upgrade existing Lynx to Lynx VP/VPE. It is necessary to upgrade all satellites and the central to move to Lynx VP/VPE. Upgrade kit includes Lynx VP Faceplate, Network LTC® Plus To Lynx VP/VPE Power Distribution Board, Cable and Hardware.

Features & Benefits

- 1 Station based flow management shortens watering window
- 2 Intuitive user interface simplifies manual irrigation
- 3 Station runtimes executed to the second helps save water
- 4 Upgrade to Lynx for enhanced central capabilities



Specifying Information—Network LTC Plus Upgrade Kit

118-0038	102-9740
<i>Kit Contains</i>	<i>Kit Contains</i>
Lynx VP Faceplate, Network LTC Plus To Lynx VP Power Distribution Board, Cable and Hardware	Lynx VPE Faceplate, Network LTC Plus To Lynx VPE Power Distribution Board, Cable and Hardware

Network LTC® Plus to LTC Pro

Do you want to change and upgrade some satellites and have them ready for Lynx? Choose this package and your satellites will be future proof. Available as complete satellites or upgrade kit for existing LTC Plus satellites. Upgrade kit includes LTC Pro Faceplate, Power Distribution Board, Cable and Hardware.

Features & Benefits

- 1 Intuitive user interface simplifies faceplate functions
- 2 Enhanced manual operations*:
 - Runtimes to the second
 - Stackable multi-manuals
 - Start/Pause/Stop
- *Only once all satellites are upgraded and the central is Lynx
- 3 Backwards compatible with SitePro®: it will keep working with your existing SitePro Central until you are ready to move to Lynx.



Specifying Information—LTC Pro Satellites

10X-XXX6XX					
Description	Configuration	Cabinet	Output	Comm.	Options
LTCR	XX	X	6	X	X
LTCR - LTC Pro	16 – 16 Stations 40 – 40 Stations	P – Plastic Green	6 – 24VAC	M – Wire R – Radio	4 – Large Terminal Block, Switches, Premium Surge

Example: When specifying a 40-station, wire communication satellite, you would specify: **LTCR40P6M4**

Specifying Information—LTC Pro Upgrade Kit

118-4838
<i>Kit Contains</i>
LTC Pro Faceplate, Power Distribution Board, Cable and Hardware



OSMAC® G3 SATELLITES



Learn more at
Toro.com



Features & Benefits



Specifications



The OSMAC® G3 Satellite

The OSMAC® G3 satellite is easy to install, troubleshoot and maintain. Economical because you buy only what you need and can expand as your site conditions change. They utilize paging technology to create one of the most convenient, dependable, and flexible satellites on the market. Employing wireless communication, these satellites are great for retrofit projects. Available as complete satellites or upgrade kit for existing OSMAC® G3 satellites. Upgrade kit includes OSMAC G3 faceplate, interface cable and hardware **Available only in selected territories.**



OSMAC® G3 SATELLITES

Features & Benefits

- 1 Low Cost Wireless Communication**
Ideal choice for upgrading existing systems. No communication wires are needed. Mounts to many existing pedestal bolt patterns.
- 2 Easily Expandable**
OSMAC G3 offers up to 64 stations in eight-station increments.
- 3 Lower Operating Costs**
The enhanced surge protection on OSMAC G3 provides lower operating costs. Ideal for high lightning areas.
- 4 Flexible Station Outputs**
Combine satellites with different output types for added system flexibility.



	0.25/0.45
0.04	0.01/0.08
0.02/0.09	0.02/0.09
0.04	0.03/0.06
0.00	0.00
0.00/0.09	0.00/0.25
0.0.17	0.04/0.17
	0.93



OSMAC® G3 SATELLITES



OSMAC® G3 Synthesized Decoder Modules
 Modules can be reprogrammed in the field – new frequency models can store up to 4 pre-programmed frequencies to transition from construction to permanent frequencies (narrowband).



SPECIFICATIONS

Operational

OSMAC G3:

- Colored LED indicators to confirm 24-, 9-, and 5-volt power to various boards within the cabinet
- LED's for each station output
- Internal antenna allows for smaller profile cabinet
- Patented Hot Post for each eight-station module

Electrical

- Input power: 120/240 V ac, 50/60 Hz
- OSMAC G3
 - 0.20 amps, 110-120 V ac, 60 Hz (no load)
 - 0.96 amps, 110-120 V ac, 60 Hz (max load)
 - 0.10 amps, 220-240 V ac, 50/60 Hz (no load)
 - 0.47 amps, 220-240 V ac, 50/60 Hz (max load)

Dimensions

- Plastic Cabinet: 43,2cm W x 101,6cm H x 40,6cm D
 (17" W x 40" H x 16" D)

Options

- Surge protection

Additional features

- Stand-alone capabilities include scheduled irrigation programs, manual program start and station multi-manual
- Received Signal Strength Indication (RSSI) at the satellite faceplate aids in system installation and troubleshooting
- Page Log records the last 100 commands received by each satellite
- Improved radio performance helps overcome difficult environmental conditions
- Available as complete satellites and an upgrade kit for existing OSMAC units

Warranty

- Two years

Specifying Information—OSMAC G3 Upgrade Kit

118-4839
<i>Kit Contains</i>
OSMAC G3 Faceplate, Interface Cable and Hardware

Specifying Information—OSMAC G3 Satellites

E-XX-X-6A-X-MX					
Description	Configuration	Cabinet	Output	Communication	Options
E	XX	X	6A	X	MX
G—OSMAC G3	16—16 Stations 24—24 Stations 32—32 Stations 40—40 Stations 48—48 Stations 56—56 Stations 64—64 Stations	P—Plastic, Green T—Desert Sand B—Tree Bark	6A—24VAC	N—Narrow Band	3—Large-capacity Terminal Block & Switches 4—Large-capacity Terminal Block & Switches, Premium Surge
Example: When specifying a 40-station, satellite in a green plastic cabinet with large terminal block, switches and premium surge you would specify: G-40P6ANM4					

Note: FCC license required. Frequency modules do not need to be ordered separately. Product shipped with four pre-programmed synthesized frequency modules (462.2125, 462.4375, 467.2125 and 467.4375).



WATCHDOG® WEATHER STATION

NEW



Learn more at [Toro.com](https://www.toro.com)



Features & Benefits



Specifications



WatchDog® Weather Station

The WatchDog® 2910ET weather station is compatible with the Toro® Lynx® Central Control for golf course irrigation systems. The package developed by Spectrum Technologies, Inc. includes a 2900ET weather station, mid-range wireless radio communications to transmit data up to 500m, and a service application that allows the station data to be incorporated into Lynx. Connecting a WatchDog® weather station to Lynx enables golf courses to control irrigation more efficiently by using real-time weather data to help manage irrigation scheduling.

WEATHER STATIONS

Features & Benefits

- ① **Compatible with Lynx Central Control System**
You can quickly and easily protect your course with one of the most powerful packages to optimize your irrigation and IPM decisions. Improve your irrigation schedules to save water.
- ② **Evapotranspiration (ET) Calculation**
Ability to calculate evapotranspiration (ET) values to support the superintendent's irrigation schedules. By basing irrigation decisions on real-time ET data, you are able to deliver water more efficiently with less waste.

- ③ **Daily Archive**
The weather station features an archive that allows you to look at historical data for that location without downloading the data. The archive is regularly updated whenever the data logger is actively collecting data. The daily archive retains the last 30 days of data.
- ④ **External Ports To Include Additional Sensors**
5 additional ports to customize your station with plug-in sensors to meet your needs.

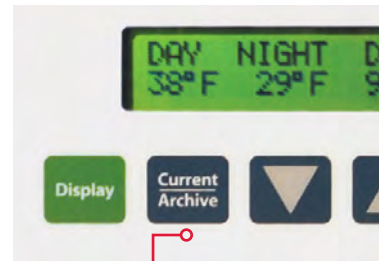
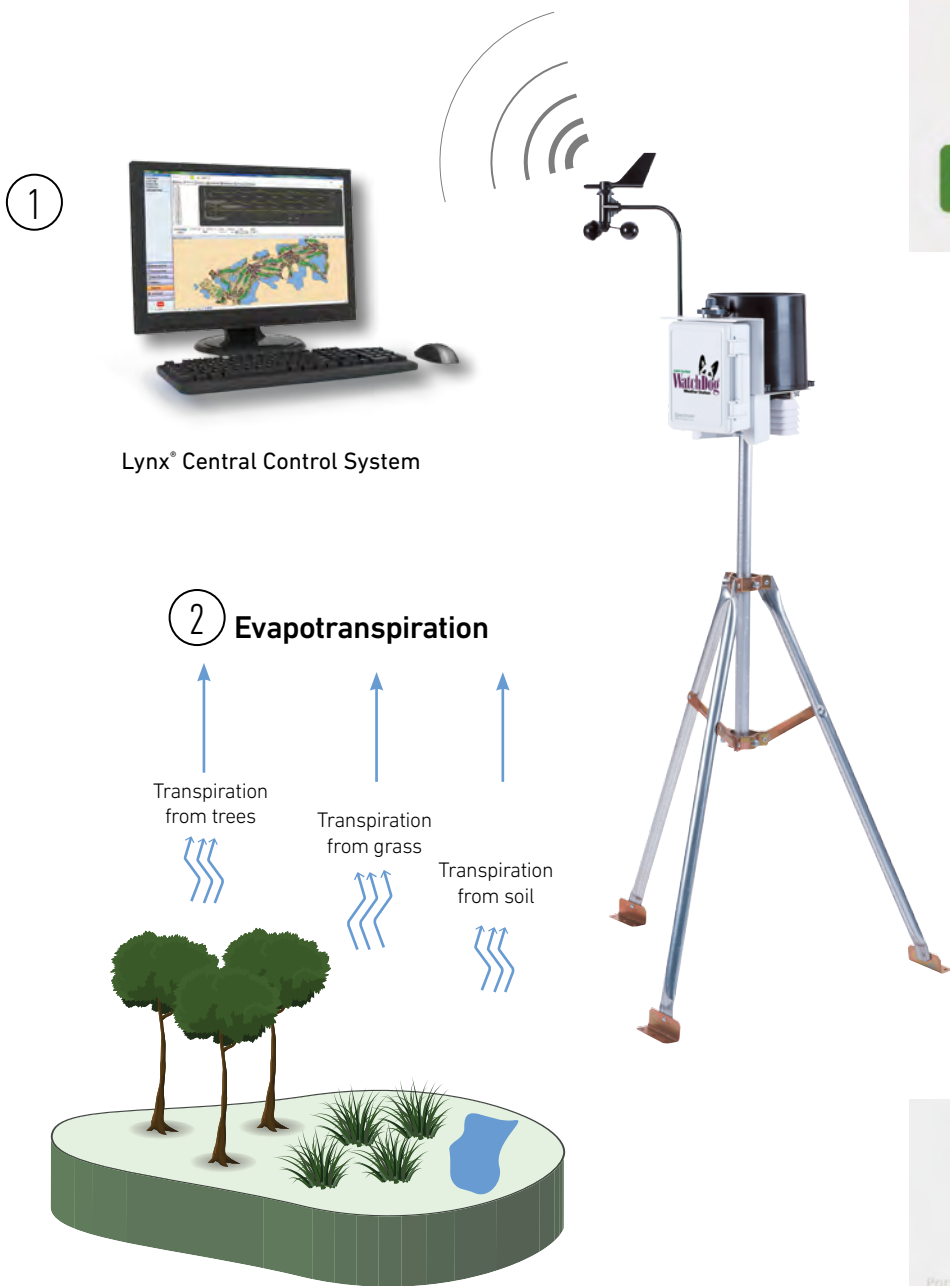

③

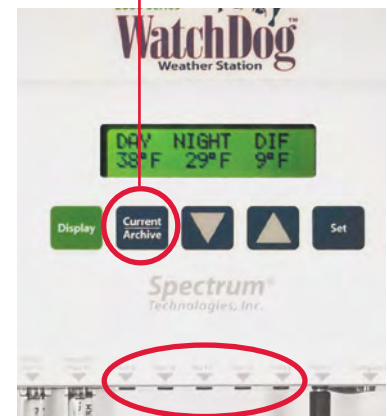

④

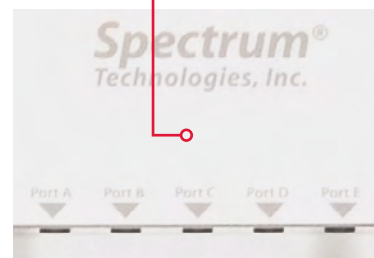



WATCHDOG® WEATHER STATION

Sensor	Measurement	Accuracy
Wind Speed	0.3-241 km/h (0.2-150 mph)	±3 km/h (±2 mph), ±5%
Wind Direction	1° increments	±4°
Air Temperature	-32° to 100°C -25° to 212°F	±0.6°C ±1°F
Relative Humidity	10% to 100% 5° to 50°C	±3%
Rainfall	0.25mm (0.01") resolution	±2% at < 5 cm (2")
Solar Radia	1-1500 W/m ²	±5%

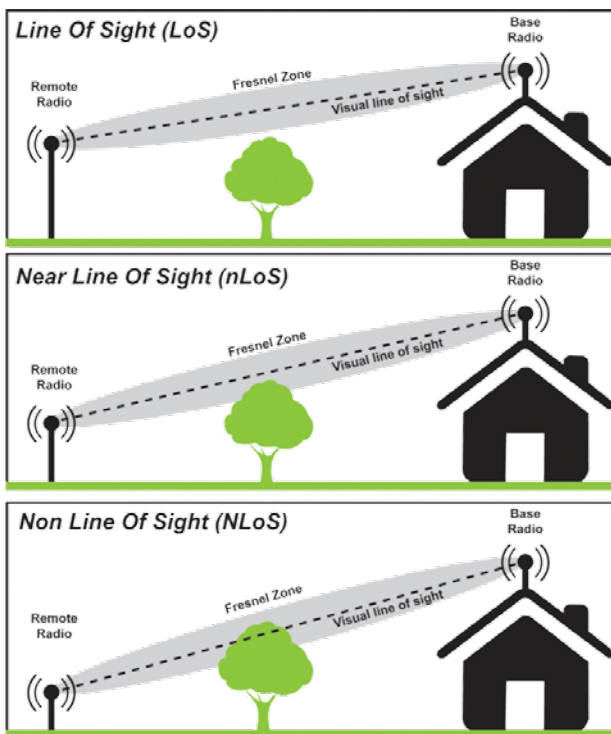

SPECIFICATIONS

Additional features

- Accurate, real-time weather information directly from your golf course
- Monitor, record and analyze several growing conditions including Temperature, Humidity, Wind Speed and Direction, Solar Radiation and Rain Fall
- Choose measurement intervals from 1 to 60 minutes (holds 183 days of data with a 30 minute interval)
- Use the LCD Display to check current and daily high/low readings without a PC

Operational

- Communication
 - Direct:
 - PC Interface Cable
 - A 29m (75ft) Direct Connect Cable
 - Short-Range Modem Pair
 - Wireless Radio (line-of-sight):
 - Short-Range transceiver: up to 305m (1000ft)
 - Mid-Range: up to 500m (1640ft)

Sensors

- Wind Speed
- Wind Direction
- Air Temperature
- Relative Humidity
- Rainfall
- Solar Radia

Installation

- Base radio features a weatherproof case and 15m (50ft) cable (terminating in a 9-pin serial connection) to allow high mounting for the greatest range. Includes AC adapter for power.

Electrical

- Power source:
 - Solar Panel
 - 4 AA Lithium Batteries (12-month battery power) or 4 AA Alkaline Batteries (10-month battery power)
 - Alternative power with AC/DC power adapter
- Available External Sensor Ports:
- Dimensions:
 - 30cm x 21.5cm x 30cm (12" x 8.5" x 12")
- Weight:
 - 2.9kg (6.4lbs)

Temperature

- Operating temperature: -30° to 55°C (-22° to 130°F)

Warranty

- Two years



Specifying Information—WatchDog® Weather Station

WATCHDOG-2910-X	
Description	Communication
WATCHDOG-2910	R
Spectrum Watchdog 2910 Toro Lynx Central	Blank - wired R - Radio, includes radio and base station with modem



SPRINKLERS



Sprinkler
Comparison Charts



INFINITY® Series
Rotors



FLEX800 Series
Rotors



FLEX R Series
Conversion Assemblies



T7
Rotor



690 Series
Rotors



590GF
Sprays



Precision™ Spray
Nozzles



Precision™ Rotating
Nozzles



Toro® Swing
Joints



Sprinkler
Tools





SPRINKLERS AND SUBSURFACE DRIP



SPRINKLER COMPARISON

Model	INF35-6/ INF55-6	INF35/ INF55	INF34/ INF54	FLX35-6/ FLX55-6	FLX35/ FLX55	FLX34/ FLX54
Page Number	48	53	58	63	68	73
Radius	13-30m (42'-100')	13-28m (43'-92')	16-30m (52'-99')	13-30m (42'-100')	13-28m (43'-92')	16-30m (52'-99')
Short Radius (mainless)	14-16m (46'-51')	10,4-15m (34'-50')		14-16m (46'-51')	10,4-15m (34'-50')	
Radius Reduction Screw		X	X		Optional	Optional
Back nozzle Capable	X	X		X	X	
Inlet size	1" and 1.5", ACME	1" and 1.5", ACME	1" and 1.5", ACME	1" and 1.5", ACME	1" and 1.5", ACME	1" and 1.5", ACME
Flow Range	27-231 LPM (7.1-61.1 GPM)	31-232 LPM (8.2-61.3 GPM)	49-234 LPM (13.0-61.8 GPM)	27-231 LPM (7.1-61.1 GPM)	31-232 LPM (8.2-61.3 GPM)	49-234 LPM (13.0-61.8 GPM)
Recommended Operating Pressure	4,5-5,5 Bar (65-80 PSI)	4,5-5,5 Bar (65-80 PSI)	4,5-5,5 Bar (65-80 PSI)	4,5-5,5 Bar (65-80 PSI)	4,5-5,5 Bar (65-80 PSI)	4,5-5,5 Bar (65-80 PSI)
Turf	X	X	X	X	X	X
High Wind	X	X	X	X	X	X
GDC 2-wire Systems	X	X	X	X	X	X
Normally Open Hydraulic System				X	X	X
Spike Guard™ Solenoid	X	X	X	X	X	X
Full Circle	X	X	X	X	X	X
Part-circle Adjustable	X	X		X	X	
Part/Full Circle In One	40°-330° and 360°	45°-335° and 360°		40°-330° and 360°	40°-330° and 360°	
Ratcheting Riser	X	X		X	X	
Check Valve				X	X	X
Smart-Arc Memory						
Trajectory Adjustment	7°-30°	25° & 15°	25° & 15°	7°-30°	25° & 15°	25° & 15°
Nozzle Base Clutching	X	X		X	X	
SMART ACCESS Compartment	X	X	X			
SMART ACCESS Cover	X	X	X			
Removable Marker	X	X	X			
Pilot Valve Serviceable Under Pressure	X	X	X			
Warranty	2 Years/ 5 Years*	2 Years/ 5 Years*	2 Years/ 5 Years*	2 Years/ 5 Years*	2 Years/ 5 Years*	2 Years/ 5 Years*

*When purchased and installed with Toro Swing Joints.

SPRINKLERS AND SUBSURFACE DRIP



SPRINKLER COMPARISON

Model	FLEX800 B Series	T7 Rotor	690	590GF
Page Number	78	94	98	101
Radius	13-29m (42'-95')	Low-flow: 38'-53' High-flow: 46'-83'	27m-33m (87'-108')	0,6m-79m (2'-26')
Short Radius (mainless)	X	X		X
Radius Reduction Screw	Optional	X		X
Back nozzle Capable	X			
Inlet size	1" NPT, BSP, ACME	1" ACME	1.5" NPT	0.5" NPT
Flow Range	27-213 LPM (7.1-56.3 GPM)	Low-flow: 6,4-48,1 LPM (1.7-12.7 GPM) High-flow: 25,8-115,5 LPM (6,8-30,5 GPM)	193-311 LPM (51.0-82.2 GPM)	0,19-17,0 LPM (.05-4.5 GPM)
Recommended Operating Pressure	3,5-6,9 Bar (50-100 PSI)	2,8-6,9 Bar (40-100 psi)	5,5-6,9 Bar (80-100 PSI)	1,4-3,4 Bar 20-50 PSI
Turf	X	X	X	X
High Wind	X			
Decoder Systems				
Low Pressure		X		X
Normally Open Hydraulic System			X	
Spike Guard™ Solenoid				
Full Circle	X	X	1 and 2 Speed	X
Part-circle Adjustable	X	X		X
Part-circle Fixed			90° and 180°	X
Part/Full Circle In One	40°-330° and 360°			
Ratcheting Riser	FLX35-6B/FLX35B			X
Check Valve	X	X	X	X
Smart-Arc Memory		X		
Below Grade		X		
Trajectory Adjustment	7°-30°/25° & 15°			
Warranty	2 Years/ 5 Years*	2 Years/ 5 Years*	2 Years/ 5 Years*	2 Years/ 5 Years*

*When purchased and installed with Toro Swing Joints.



INFINITY® SERIES WITH SMART ACCESS®



Learn more at
toroinfinity.com



The patented INFINITY Series sprinklers are designed to save you time and with your course's future in mind.

Whether you choose a Toro Satellite or 2-wire control system the patented SMART ACCESS® design enables you to add new technology for decades to come. You won't need to invest in new sprinklers as technology advances, because the INFINITY Series are built for flexible expansion, not replacement, to keep your course looking its best and your golfers playing.

Click to watch Toro
INFINITY Video



TORO



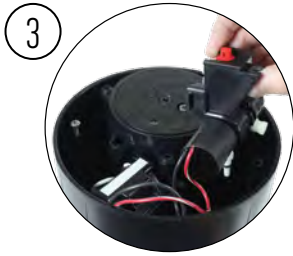

1 SMART ACCESS
Provides top accessibility to all critical components.

- No digging or unsightly turf repair scars
- No buried wire splices or ground faults
- Pilot valve removable with water "ON"
- Lower long term cost of ownership
- Customizable marker
- Increased labor efficiency

2 Wire splices protected in the SMART ACCESS compartment and accessible from the top
The protective enclosure isolates wire splices from the soil and potential shorts to ground. Provides access for system troubleshooting and repairs **without digging!**

3 Pilot valve accessible from the top
Toro's patented CHECK FLOW™ feature facilitates troubleshooting, pressure adjustments, solenoid and pilot valve servicing **without turning the water off or digging!**

4 GDC 2-wire module accessible from the top
Allows for GDC module retrieval, system troubleshooting and system repairs **without digging!**

5 Future-proof your investment
The SMART ACCESS compartment provides room to grow. Whatever the future holds, this sprinkler will be ready. Getting smarter **without digging!**

6 Customizable marker

- Customizable with golf course logo and/or yardage marker
- Replaceable cover if damaged



INFINITY® SERIES WITH SMART ACCESS®



Trajectory adjustment

INFINITY® SERIES models are available. In 24-position TruJectory™ or Dual trajectory to help fight the wind, avoid obstacles or to reduce the radius.



Industry's largest high performance nozzle selection

From 6,0 m to 30,5 m (20' to 100') we've got you covered! Only Toro provides the flexibility to optimize your system for maximum uniformity.



Nozzle base clatching

Hot spot watering has never been easier, simply turn, hold and shoot to put down as much water as needed.

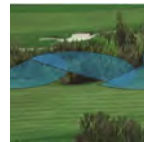

Ratcheting riser

Align part circle quickly and easily or adjust watering locations to suit seasonal needs. Standard on all INFINITY® part circle models.



Part- and full-circle models in one

The sprinklers can be full circle today and part circle tomorrow allowing you to simply and economically adjust the area of coverage to match your seasonal needs or meet water rationing mandates.



Once installed, there is no difference in size between the INFINITY Series and your existing 800S and DT models: The same height as your existing 1" or 1.5" 800S and DT models, and the same diameter as your 1.5" models

Flexible and Configurable Models

Two Body Sizes	Five Activation Types	Two Main Nozzle Trajectories	Two Part Circle Models
<ul style="list-style-type: none"> -25 mm (1") with ACME thread -40 mm (1.5") with ACME thread 	<ul style="list-style-type: none"> -Standard solenoid -Spike Guard solenoid -Nickel plated Spike Guard solenoid -DC Latching solenoid -Integrated GDC module w/ DCL solenoid 	<ul style="list-style-type: none"> -24-position TruJectory™; 7°-30° -Dual trajectory; 25° or 15° 	<ul style="list-style-type: none"> -One with 24 position TruJectory™ -One with Dual trajectory



INFINITY® SERIES GOLF ROTORS INF35-6/INF55-6



Learn more at
toroinfinity.com



INFINITY 35-6/55-6 Series with Smart Access

With the industry's largest selection of high performance nozzles and TruJectory™ adjustment the New INFINITY 35-6/55-6 Series with Smart Access allows you to put water precisely where you want it for maximum distribution uniformity. And the part/full circle drive allows you to simply and economically adjust the area of coverage to match your seasonal watering needs or meet water rationing mandates in seconds with no disassembly or additional parts required.

Features & Benefits



Specifications



Performance Data



SMART ACCESS provides top accessibility to all critical components and room to grow for whatever the future holds.





INFINITY® SERIES GOLF ROTORS INF35-6/INF55-6

Features & Benefits

- ① **Industry's Largest Nozzle Selection**
Nozzles from 12,8m - 30,5m (42' to 100') radius plus a wide assortment of back nozzles lets you put the precise amount of water exactly where you need it. All nozzles threaded in from the front.
- ② **Hot Spot Watering**
Nozzle base can be turned in either direction and held to put down as much water as needed, precisely where you want it. Standard on all Toro Part circle Golf rotors!

- ③ **Adjustment With No Disassembly**
Toro exclusive, simply pull up the riser and ratchet it to the precise position you want to water.
- ④ **True Part and Full-Circle in One – 40° - 330° Part Circle**
These sprinklers can be full circle today and part circle tomorrow allowing you to simply and economically adjust the area of coverage to match your seasonal needs or meet water rationing mandates.



①

Pop-up height to nozzle:
8,25cm (3.25")

INF35-6:
25cm (10")



②

Weight:
INF35-6: 1,95kg (4.31 lbs.)

INF55-6:
29cm (11.38")

Weight:
INF55-6: 1,33kg (5.13 lbs.)



TruJectory® – 24 Positions
From 7° - 30° in 1° increments put water where you want it. Adjust from the top of the sprinkler in seconds, wet or dry. This flexibility lets you tackle every obstacle on the course; wind, trees, bunkers, mounds and more.



INFINITY® SERIES GOLF ROTORS INF35-6/INF55-6



INF35-6 Conversion Upgrades

Models	Description
INF35-6-3134	INF35-6 w/31-34 Nozzles (33 Nozzle Installed)
INF35-6-3537	INF35-6 w/35-37 Nozzles (35 Nozzle Installed)



INF55-6 Conversion Upgrades

Models	Description
INF55-6-5154	INF55-6 w/51-54 Nozzles (53 Nozzle Installed)
INF55-6-5558	INF55-6 w/55-58 Nozzles (55 Nozzle Installed)
INF55-6-59	INF55-6 w/59 Nozzle installed



Operating Specifications

Inlet:

- INF35-6: 25mm (1") ACME
- INF55-6: 40mm (1.5") ACME

Radius:

- INF35-6: 12,8 – 28,0m (42' – 92')
- INF55-6: 15,9 – 30,5m (52' – 100')

Flow Rate:

- INF35-6: 26,9-171,5 LPM (7.1 – 45.3 GPM)
- INF55-6: 52,6-231,3 LPM (13.9 – 61.1 GPM)

Precipitation Rates:

- INF35-6:
Minimum: 9mm/hr (0.37"/hr);
Maximum: 13,5mm/hr (0.53"/hr)

- INF55-6:
Minimum: 11mm/hr (0.43"/hr);
Maximum: 15mm/hr (0.60"/hr)

Pilot Valve: Selectable at 3,4; 4,5; 5,5; and 6,9 Bar (50, 65, 80 and 100 psi)

Recommended Operating Pressure Range:

- 4,5-6,9 Bar (65-100 psi)
- Maximum: 10,3 Bar (150 psi)
- Minimum: 2,8 Bar (40 psi)

Activation Type

- Standard Solenoid
- Spike Guard Solenoid
- Nickel-plated Spike Guard Solenoid
- DC Latching Solenoid (DCLS)
- Integrated GDC Module w/DCLS

Trajectory: 24 positions from 7° - 30° in 1° increments

Additional Features

INF35-6 has eight nozzle variations (30, 31, 32, 33, 34, 35, 36 and 37)

INF55-6 has nine nozzle variations (51, 52, 53, 54, 55, 56, 57, 58 and 59)

Four in-line nozzles, rotating stream pattern

One back nozzle position

Stator variations: INF35-6 – 3 and NF55-6 – 3

Dimensions

SMART ACCESS™ Cover and Compartment Diameter:

- INF35-6: 19cm (7.5")
- INF55-6: 19cm (7.5")

Body height:

- INF35-6: 25cm (10")
- INF55-6: 29cm (11.38")

Weight:

- INF35-6: 1,95kg (4.31 lbs.)
- INF55-6: 1,33kg (5.13 lbs.)

Pop-up height to nozzle: 8,25cm (3.25")

Warranty

Two years; Five years when installed with Toro Swing Joints

Specifying Information—INF35-6 & INF55-6

INF5-XXX-X6					
Body Inlet	Arc	Nozzle	Pressure Regulation*	Activation Type	Trajectory
INFX	5	XX	X	X	6
3—1" 5—1½"	5—Part-circle and Full-circle in One	INF35—30, 31, 32, 33, 34, 35, 36, 37 INF55—51, 52, 53, 54, 55, 56, 57, 58, 59	6— 4,5 bar (65 psi) 8— 5,5 Bar (80 psi) 1— 6,9 Bar (100 psi)	1—Standard Solenoid 2—Spike Guard™ Solenoid 3—Nickel-plated Spike Guard Solenoid 4—DC Latching Solenoid (DCLS) 5—Integrated GDC Module w/DCLS	6—24-position TruJectory
Example: When specifying an INF35-6 Series Sprinkler with #34 nozzle, pressure regulation at 4,5 bar (65 psi) and Spike Guard you would specify: INF35-346-26					

* All sprinklers are equipped with the selectable pilot valve that allows settings at 3,4; 4,5; 5,5; and 6,9 Bar (50, 65, 80 and 100 psi).

Note: Not all models available.



INFINITY® SERIES GOLF ROTORS INF35-6/INF55-6

INF35-6/INF55-6 Trajectory Performance—(Metric)

Nozzle/Bar/LPM	#31/51 Nozzle @ 4,5 Bar							#32/52 Nozzle @ 4,5 Bar															
	7°	10°	15°	20°	25°	30°	7°	10°	15°	20°	25°	30°											
Trajectory																							
"A" Radius	14,0	14,0	15,2	15,5	16,2	16,5	15,2	14,0	14,9	14,9	15,2	15,5	16,8	19,2	19,5	16,5	19,8						
"B" Spray Height	1,2	1,2	1,5	1,8	2,4	3,0	3,4	4,0	4,0	4,6	0,9	1,2	1,2	1,8	2,7	3,7	3,4	4,6	4,0				
"C" Distance from Head	7,6	7,9	7,6	8,2	7,9	9,8	10,1	11,6	10,1	12,2	10,1	12,4	6,1	6,7	7,3	7,9	8,5	9,4	10,4	10,7	10,4	10,4	9,1

Nozzle/Bar/LPM	#33/53 Nozzle @ 4,5 Bar						#34/54 Nozzle @ 4,5 Bar															
	7°	10°	15°	20°	25°	30°	7°	10°	15°	20°	25°	30°										
Trajectory																						
"A" Radius	16,5	17,1	18,0	18,9	20,1	20,7	18,6	17,7	18,3	19,2	20,4	22,6	21,3									
"B" Spray Height	1,2	1,5	1,5	1,8	2,1	2,7	4,0	4,6	1,2	1,5	1,2	1,8	1,8	2,4	3,4	3,0	4,3	5,2				
"C" Distance from Head	7,0	9,1	8,5	10,1	9,8	10,4	10,7	10,7	11,3	10,7	11,3	7,3	9,4	7,9	10,4	10,7	12,2	11,9	12,5	11,9	11,9	12,8

Nozzle/Bar/LPM	#35/55 Nozzle @ 4,5 Bar						#36/56 Nozzle @ 5,5 Bar													
	7°	10°	15°	20°	25°	30°	7°	10°	15°	20°	25°	30°								
Trajectory																				
"A" Radius	18,0	18,6	18,9	19,5	20,1	21,3	23,2	22,6	23,5	19,5	21,9	20,7	22,2	23,2	22,9	24,4	25,0	25,6	25,9	25,0
"B" Spray Height	1,2	1,8	1,5	1,8	2,1	2,7	3,4	4,6	5,2	1,5	2,1	2,7	4,3	5,2	6,7					
"C" Distance from Head	9,1	10,4	9,8	11,0	11,0	13,1	13,1	13,7	13,1	13,7	13,1	13,7	7,6	11,6	12,2	13,7	14,9	13,7		

Nozzle/Bar/LPM	#37/57 Nozzle @ 5,5 Bar						#58 Nozzle @ 5,5 Bar											
	7°	10°	15°	20°	25°	30°	7°	10°	15°	20°	25°	30°						
Trajectory																		
"A" Radius	19,8	21,9	21,0	22,6	23,8	23,5	25,0	25,3	26,2	27,1	25,6	25,9	22,9	23,5	25,3	26,5	28,0	26,8
"B" Spray Height	1,5	2,1	2,7	4,3	5,5	6,7	1,8	2,1	3,0	4,6	5,5	6,7						
"C" Distance from Head	9,1	11,9	12,5	14,0	15,2	14,0	11,6	12,2	13,1	14,3	15,8	14,6						

Nozzle/Bar/LPM	#59 Nozzle @ 5,5 Bar					
	7°	10°	15°	20°	25°	30°
Trajectory						
"A" Radius	23,5	23,8	25,6	27,1	29,3	28,0
"B" Spray Height	2,1	2,4	3,4	4,9	6,4	7,6
"C" Distance from Head	12,8	13,4	13,7	14,3	16,2	14,9

Information is for reference only. Actual results may vary.

INF35-6/INF55-6 Trajectory Performance—(U.S.)

Nozzle/PSI/GPM	#31/51 Nozzle @ 65 psi						#32/52 Nozzle @ 65 psi					
	7°	10°	15°	20°	25°	30°	7°	10°	15°	20°	25°	30°
Trajectory												
"A" Radius	46'	46'	50'/51'	53'	54'	50'	46'/49'	49'/50'	51'	55'	63'/64'	54'/65'
"B" Spray Height	4'	4'	5'/6'	8'/10'	11'/13'	13'/15'	3'/4'	4'	6'	9'	12'/11'	15'/13'
"C" Distance from Head	25'/26'	25'/27'	26'/32'	33'/38'	33'/40'	33'/41'	20'/22'	24'/26'	28'/31'	34'/35'	34'	34'/30'

Nozzle/PSI/GPM	#33/53 Nozzle @ 65 psi						#34/54 Nozzle @ 65 psi					
	7°	10°	15°	20°	25°	30°	7°	10°	15°	20°	25°	30°
Trajectory												
"A" Radius	54'	56'	59'	62'	66'/68'	61'	58'	60'	63'	67'	74'	70'
"B" Spray Height	4'/5'	5'/6'	7'	9'	13'	15'	4'/5'	4'/6'	6'/8'	11'/10'	14'	17'
"C" Distance from Head	23'/30'	28'/33'	32'	34'/35'	35'/37'	35'/37'	24'/31'	26'/34'	35'/40'	39'/41'	39'	39'/42'

Nozzle/PSI/GPM	#35/55 Nozzle @ 65 psi						#36/56 Nozzle @ 80 psi					
	7°	10°	15°	20°	25°	30°	7°	10°	15°	20°	25°	30°
Trajectory												
"A" Radius	59'	61'/62'	64'/66'	70'	76'	74'/77'	64'/72'	68'/73'	76'/75'	80'/82'	84'/85'	82'
"B" Spray Height	4'/6'	5'/6'	7'/9'	11'	15'	17'	5'	7'	9'	14'	17'	22'
"C" Distance from Head	30'/34'	32'/36'	36'/43'	43'/45'	43'/45'	43'/45'	25'	38'	40'	45'	49'	45'

Nozzle/PSI/GPM	#37/57 Nozzle @ 80 psi						#58 Nozzle @ 80 psi					
	7°	10°	15°	20°	25°	30°	7°	10°	15°	20°	25°	30°
Trajectory												
"A" Radius	65'/72'	69'/74'	78'/77'	82'/83'	86'/89'	84'/85'	75'	77'	83'	87'	92'	88'
"B" Spray Height	5'	7'	9'	14'	18'	22'	6'	7'	10'	15'	18'	22'
"C" Distance from Head	30'	39'	41'	46'	50'	46'	38'	40'	43'	47'	52'	48'

Nozzle/PSI/GPM	#59 Nozzle @ 80 psi					
	7°	10°	15°	20°	25°	30°
Trajectory						
"A" Radius	77'	78'	84'	89'	96'	92'
"B" Spray Height	7'	8'	11'	16'	21'	25'
"C" Distance from Head	42'	44'	45'	47'	53'	49'

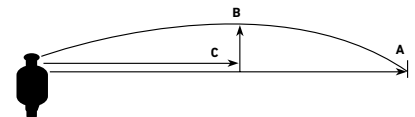

Information is for reference only. Actual results may vary.



INFINITY® SERIES GOLF ROTORS INF35-6/INF55-6

INF35-6 Series Performance Chart—(Metric)

Base Pressure			Nozzle Set 30		Nozzle Set 31		Nozzle Set 32		Nozzle Set 33		Nozzle Set 34		Nozzle Set 35		Nozzle Set 36		Nozzle Set 37	
			(White)		(Yellow)		(Blue)		(Brown)		(Orange)		(Green)		(Gray)		(Black)	
			102-2208		102-4587		102-4588		102-4589		102-0728		102-0729		102-0730		102-4261	
Bar	kPa	kg/cm ²	Radius	LPM	Radius	LPM	Radius	LPM	Radius	LPM	Radius	LPM	Radius	LPM	Radius	LPM	Radius	LPM
3,4	340	3,47	12,8	26,9	15,9	51,9	18,6	64,7	19,5	76,5	21,0	103,7	—	—	—	—	—	—
4,5	450	4,59	13,7	32,9	16,5	58,7	19,2	77,6	20,1	86,7	22,6	113,6	23,2	122,6	24,4	128,7	—	—
5,5	550	5,61	14,0	36,3	17,4	64,3	20,4	85,5	21,4	95,8	23,5	125,7	24,1	135,5	25,6	141,9	26,2	154,4
6,9	690	7,04	14,6	42,4	18,0	71,5	22,0	95,4	22,6	106,7	24,4	140,0	25,6	151,0	26,8	160,9	28,1	171,5
Stator			102-6929 Blue				102-1939 Yellow						102-1940 White					
Conversions							INF35-6-3134						INF35-6-3537					

■ Not recommended at these pressures. Radius shown in meters. Toro recommends the use of a 1 1/4" (30mm) swing joint at flows over 25-GPM (95-LPM). Sprinkler radius of throw per ASAE standard S398.1.

INF35-6 Series Performance Chart—(U.S.)

Base Pressure			Nozzle Set 30		Nozzle Set 31		Nozzle Set 32		Nozzle Set 33		Nozzle Set 34		Nozzle Set 35		Nozzle Set 36		Nozzle Set 37	
			(White)		(Yellow)		(Blue)		(Brown)		(Orange)		(Green)		(Gray)		(Black)	
			102-2208		102-4587		102-4588		102-4589		102-0728		102-0729		102-0730		102-4261	
psi	Radius	GPM	Radius	GPM	Radius	GPM	Radius	GPM	Radius	GPM	Radius	GPM	Radius	GPM	Radius	GPM	Radius	GPM
50	42	7.1	52	13.7	61	17.1	64	20.2	69	27.4	—	—	—	—	—	—	—	
65	45	8.7	54	15.5	63	20.5	66	22.9	74	30.0	76	32.4	80	34.0	—	—	—	
80	46	9.6	57	17.0	67	22.6	70	25.3	77	33.2	79	35.8	84	37.5	86	40.8	—	
100	48	11.2	59	18.9	72	25.2	74	28.2	80	37.0	84	39.9	88	42.5	92	45.3	—	
Stator			102-6929 Blue				102-1939 Yellow						102-1940 White					
Conversions							INF35-6-3134						INF35-6-3537					

INF55-6 Series Performance Chart—(Metric)

Base Pressure			Nozzle Set 51		Nozzle Set 52		Nozzle Set 53		Nozzle Set 54		Nozzle Set 55		Nozzle Set 56		Nozzle Set 57		Nozzle Set 58		Nozzle Set 59	
			(Yellow)		(Blue)		(Brown)		(Orange)		(Green)		(Gray)		(Black)		(Red)		(Beige)	
			102-4587		102-4588		102-4589		102-0728		102-0729		102-0730		102-4261		102-4260		102-4259	
Bar	kPa	kg/cm ²	Radius	LPM	Radius	LPM	Radius	LPM	Radius	LPM	Radius	LPM	Radius	LPM	Radius	LPM	Radius	LPM	Radius	LPM
3,4	340	3,47	15,9	52,6	18,9	65,9	20,1	78,3	21,0	108,3	—	—	—	—	—	—	—	—	—	
4,5	450	4,59	16,5	59,4	19,5	78,3	20,7	88,6	22,6	113,1	23,2	127,9	24,7	135,1	—	—	—	—	—	
5,5	550	5,61	17,4	65,1	20,7	86,7	22,0	97,7	23,5	130,2	24,1	140,8	25,9	149,1	27,1	165,0	28,1	179,8	29,3	215,7
6,9	690	7,04	18,0	72,3	22,3	96,5	23,2	108,6	24,4	144,6	25,6	156,3	27,1	165,4	28,7	183,6	29,0	194,9	30,5	231,3
Stator			102-1939 Yellow				102-1940 White						102-1941							
Conversions			INF55-6-5154				INF55-6-5558						INF55-6-59							

■ Not recommended at these pressures. Radius shown in meters. Toro recommends the use of a 1 1/4" (30mm) swing joint at flows over 25-GPM (95-LPM). Sprinkler radius of throw per ASAE standard S398.1.

INF55-6 Series Performance Chart—(U.S.)

Base Pressure			Nozzle Set 51		Nozzle Set 52		Nozzle Set 53		Nozzle Set 54		Nozzle Set 55		Nozzle Set 56		Nozzle Set 57		Nozzle Set 58		Nozzle Set 59	
			(Yellow)		(Blue)		(Brown)		(Orange)		(Green)		(Gray)		(Black)		(Red)		(Beige)	
			102-4587		102-4588		102-4589		102-0728		102-0729		102-0730		102-4261		102-4260		102-4259	
psi	Radius	GPM	Radius	GPM	Radius	GPM	Radius	GPM	Radius	GPM	Radius	GPM	Radius	GPM	Radius	GPM	Radius	GPM	Radius	GPM
50	52	13.9	62	17.4	66	20.7	69	28.6	—	—	—	—	—	—	—	—	—	—	—	
65	54	15.7	64	20.8	68	23.4	74	31.2	76	33.8	81	35.7	—	—	—	—	—	—	—	
80	57	17.2	68	22.9	72	25.8	77	34.4	79	37.2	85	39.4	89	43.6	92	47.5	96	57.0	—	
100	59	19.1	73	25.5	76	28.7	80	38.2	84	41.3	89	43.7	94	48.5	95	51.1	100	61.1	—	
Stator			102-1939 Yellow						102-1940 White						102-1941					
Conver.			INF55-6-5154						INF55-6-5558						INF55-6-59					

■ Not recommended at these pressures. Radius shown in feet. Toro recommends the use of a 1 1/4" swing joint at flows over 25-GPM (95-LPM). Sprinkler radius data collected in Toro's zero wind test facility per ASAE standard S398.1. Actual site conditions must be considered when selecting the appropriate nozzle. All sprinklers are equipped with the selectable pilot valve that allows settings at 3,4; 4,5; 5,5; and 6,9 Bar (50, 65, 80 and 100 psi).





INFINITY® SERIES GOLF ROTORS INF35/INF55



Learn more at toroinfinity.com



Dual Trajectory

The 25° setting provides maximum distance of throw and the 15° setting provides improved wind performance, radius reduction and obstacle avoidance.



Features & Benefits



Specifications



Performance Data



Click to watch Toro **INFINITY Video**



The New INFINITY 35/55 Series with Smart Access

features a dual trajectory main nozzle that provides exceptional nozzle performance at the 25° standard angle position and great performance in windy applications at the 15° low angle position. And the part/full circle drive allows you to adjust the area of coverage to match your seasonal watering needs or meet water rationing mandates in seconds with no additional parts required.

TORO.





INFINITY® SERIES GOLF ROTORS INF35/INF55

Features & Benefits

- 1 Industry's Largest Nozzle Selection**
Nozzles from 12,8m - 30,5m (42' to 100') radius plus a wide assortment of back nozzles lets you put the precise amount of water exactly where you need it. All nozzles threaded in from the front.
- 2 Stainless Steel Valve Seat**
Eliminates body damage from rocks and debris. This in-destructible stainless steel seat is molded to the body and virtually eliminates body replacements due to seat damage. Standard on all Toro Golf rotors!

- 3 Radius Reduction Screw**
Allows for fine tuning the radius to exactly the distance you need. In combination with main nozzle sizing and trajectory adjustment the radius reduction screw can effectively reduce the sprinkler throw down to 30'.
- 4 True Part and Full-Circle in One – 40° - 330° part circle**
These sprinklers can be full circle today and part circle tomorrow allowing you to simply and economically adjust the area of coverage to match your seasonal needs or meet water rationing mandates.

1



2



Weight:
INF35: 1,93kg (4.26 lbs.)

4



3

Weight:
INF55: 2,30 (5.08 lbs.)

SMART ACCESS provides top accessibility to all critical components and room to grow for whatever the future holds.

INFINITY® SERIES GOLF ROTORS INF35/INF55



INF35 Conversion Upgrades

Models	Description
• INF35-3134	INF35 w/31-34 Nozzles (#3 Nozzle Installed)
• INF35-3537	INF35 w/35-37 Nozzles (#5 Nozzle Installed)



INF55 Conversion Upgrades

Models	Description
• INF55-5154	INF55 w/51-54 Nozzles (#3 Nozzle Installed)
• INF55-5558	INF55 w/55-58 Nozzles (#5 Nozzle Installed)
• INF55-59	INF55 w/59 Nozzle



Operating Specifications

Inlet:

- INF35: 25mm (1") ACME
- INF55: 40mm (1.5") ACME

Radius:

- INF35: 13,1 – 25,3m (43' – 83')
- INF55: 16,7 – 28,0m (55' – 92')

Flow Rate:

- INF35: 31,0 – 179,0 LPM (8.2 – 47.8 GPM)
- INF55: 53,0 – 232,0 LPM (14.1 – 61.3 GPM)

Precipitation Rates:

- INF35: Minimum: 10,4 mm/hr (0.41"/hr); Maximum: 11,4 mm/hr (0.45"/hr)
- INF55: Minimum: 11,7 mm/hr (0.46"/hr); Maximum: 14,7 mm/hr (0.58"/hr)

Pilot Valve: Selectable at 3,4; 4,5; 5,5; and 6,9 Bar (50, 65, 80 and 100 psi)

Recommended Operating Pressure Range:

- 4,5-6,9 Bar (65-100 psi)
- Maximum: 10,3 Bar (150 psi)
- Minimum: 2,8 Bar (40 psi)

Activation Type

- Standard Solenoid
- Spike Guard Solenoid
- Nickel-plated Spike Guard Solenoid
- DC Latching Solenoid (DCLS)
- Integrated GDC Module w/DCLS

Nozzle Selection

INF35 has eight nozzle variations (30, 31, 32, 33, 34, 35, 36 & 37)

INF55 has nine nozzle variations (51, 52, 53, 54, 55, 56, 57, 58 & 59)

Three in-line nozzles, rotating stream pattern

Two back nozzle positions

Stator variations: 3

Radius reduction screw 363-4839 for fine tuning

Dimensions

SMART ACCES® Cover And Compartment Diameter:

- INF35: 19cm (7.5")
- INF55: 19cm (7.5")

Body height:

- INF35: 25cm (10")
- INF55: 29cm (11.38")

Weight:

- INF35: 1,93kg (4.26 lbs.)
- INF55: 2,30 (5.08 lbs.)

Pop-up height to nozzle: 8,25cm (3.25")

Warranty

Two years; Five years when installed with Toro Swing Joints



Specifying Information—INF35 & INF55

INF5-XXX-XX					
Body Inlet	Arc	Nozzle	Pressure Regulation*	Activation Type	Trajectory
INFX	5	XX	X	X	6
3—1" 5—1½"	5—Part-circle and Full-circle In One	INF35—30, 31, 32, 33, 34, 35, 36, 37 INF55—51, 52, 53, 54, 55, 56, 57, 58, 59	6— 4,5 bar (65 psi) 8— 5,5 bar (80 psi) 1— 6,9 bar (100 psi)	1—Standard Solenoid 2—Spike Guard™ Solenoid 3—Nickel-plated Spike Guard Solenoid 4—DC Latching Solenoid (DCLS) 5—Integrated GDC Module w/DCLS	6—24-position TruJectory
Example: When specifying an INF35 Series Sprinkler with #34 nozzle, pressure regulation at 4,5 bar (65 psi) and Spike Guard you would specify: INF35-346-2					

* All sprinklers are equipped with the selectable pilot valve that allows settings at 3,4; 4,5; 5,5; and 6,9 Bar (50, 65, 80 and 100 psi).
Note: Not all models available.



INFINITY® SERIES GOLF ROTORS INF35/INF55

INF35 Performance Data—25° – (Metric)

Front Nozzle Positions			Nozzle Set 30		Nozzle Set 31		Nozzle Set 32		Nozzle Set 33		Nozzle Set 34		Nozzle Set 35		Nozzle Set 36		Nozzle Set 37	
			102-2208		102-6906		102-0726		102-6907		102-0728		102-6955		102-6935		102-6936	
			Yellow	Biege	Yellow	Brown	Yellow	Yellow	Yellow	Yellow	Yellow	Yellow	Yellow	Yellow	Yellow	Green	Green	Green
102-5670	102-6942	102-5670	102-5671	102-5670	102-6884	102-5670	102-6884	102-5670	102-6884	102-5670	102-6884	102-5670	102-6885	102-6531	102-6885	102-6531	102-6885	
Back Nozzle Positions																		
			102-4335		102-4335		102-4335		102-4335		102-4335		102-4335		102-4335		102-4335	
			Red Plug	Red Plug	Red Plug	Red Plug	Red Plug	Red Plug	Red Plug	Red Plug	Red Plug	Red Plug	Red Plug	Red Plug	Red Plug	Red Plug	Red Plug	Red Plug
Bar	kPa	kg/cm2	Radius	LPM	Radius	LPM	Radius	LPM	Radius	LPM	Radius	LPM	Radius	LPM	Radius	LPM	Radius	LPM
3,4	340	3,47	13,1	31,0	16,2	52,2	17,1	69,3	18,6	82,1	—	—	—	—	—	—	—	—
4,5	450	4,59	13,7	37,9	16,2	58,7	18,0	77,6	19,5	92,4	20,7	106,7	22,0	129,1	—	—	—	—
5,5	550	5,61	14,0	43,5	17,4	65,5	18,9	85,9	20,4	102,6	21,7	117,7	22,9	143,1	23,8	152,5	24,4	166,5
6,9	690	7,04	14,3	50,7	18,0	72,3	19,8	94,2	21,4	112,8	22,6	129,1	24,1	154,8	24,7	165,8	25,3	179,0

INF35 Series Performance Chart—15°

Bar	kPa	kg/cm2	Radius	LPM	Radius	LPM	Radius	LPM	Radius	LPM	Radius	LPM	Radius	LPM	Radius	LPM	Radius	LPM
3,4	340	3,47	13,1	31,0	15,9	51,5	17,7	68,5	18,6	81,4	—	—	—	—	—	—	—	—
4,5	450	4,59	13,7	37,9	16,5	57,9	18,3	76,8	19,5	91,6	19,8	103,3	21,0	125,3	—	—	—	—
5,5	550	5,61	14,0	43,5	17,7	65,1	19,5	85,5	21,0	101,4	21,0	114,3	22,9	139,3	23,2	150,3	23,2	162,4
6,9	690	7,04	14,3	50,7	18,3	71,9	20,1	93,5	21,7	111,7	22,0	124,5	23,8	149,5	25,0	161,2	25,0	174,5
Stator			102-6929 Blue				102-1939 Yellow						102-1940 White					
Conversions			INF35-3134												INF35-3537			

INF35 Performance Data—25° – (U.S.)

Front Nozzle Positions			Nozzle Set 30		Nozzle Set 31		Nozzle Set 32		Nozzle Set 33		Nozzle Set 34		Nozzle Set 35		Nozzle Set 36		Nozzle Set 37	
			102-2208		102-6906		102-0726		102-6907		102-0728		102-6955		102-6935		102-6936	
			Yellow	Biege	Yellow	Brown	Yellow	Yellow	Yellow	Yellow	Yellow	Yellow	Yellow	Yellow	Yellow	Green	Green	Green
102-5670	102-6942	102-5670	102-5671	102-5670	102-6884	102-5670	102-6884	102-5670	102-6884	102-5670	102-6884	102-5670	102-6885	102-6531	102-6885	102-6531	102-6885	
Back Nozzle Positions																		
			102-4335		102-4335		102-4335		102-4335		102-4335		102-4335		102-4335		102-4335	
			Red Plug	Red Plug	Red Plug	Red Plug	Red Plug	Red Plug	Red Plug	Red Plug	Red Plug	Red Plug	Red Plug	Red Plug	Red Plug	Red Plug	Red Plug	Red Plug
PSI	Radius	GPM	Radius	GPM	Radius	GPM	Radius	GPM	Radius	GPM	Radius	GPM	Radius	GPM	Radius	GPM		
50	43	8.2	53	13.8	56	18.3	61	21.7	65	25.3	—	—	—	—	—	—		
65	45	10.0	53	15.5	59	20.5	64	24.4	68	28.2	72	34.1	—	—	—	—		
80	46	11.5	57	17.3	62	22.7	67	27.1	71	31.1	75	37.8	78	40.3	80	44.0		
100	47	13.4	59	19.1	65	24.9	70	29.8	74	34.1	79	40.9	81	43.8	83	47.3		

INF35 Series Performance Chart—15°

PSI	Radius	GPM	Radius	GPM	Radius	GPM	Radius	GPM	Radius	GPM	Radius	GPM	Radius	GPM	Radius	GPM		
50	43	8.2	52	13.6	58	18.1	61	21.5	62	25.6	—	—	—	—	—	—		
65	45	10.0	54	15.3	60	20.3	64	24.2	65	27.3	69	33.1	—	—	—	—		
80	46	11.5	58	17.2	64	22.6	69	26.8	69	30.2	75	36.8	76	39.7	76	42.9		
100	47	13.4	60	19.0	66	24.7	71	29.5	72	32.9	78	39.5	82	42.6	82	46.1		
Stator			102-6929 Blue				102-1939 Yellow						102-1940 White					
Conversions			INF35-3134												INF35-3537			

■ Not recommended at these pressures.

Toro recommends the use of a 1¼" swing joint at flows over 25-GPM (95-LPM). Sprinkler radius of throw per ASAE standard S398.1. All sprinklers are equipped with the selectable pilot valve that allows settings at 3,4; 4,5; 5,5; and 6,9 Bar (50, 65, 80 and 100 psi).

INF35 Nozzle Apex—(Metric)

Pressure	Nozzle	Apex at 15°	Apex at 25°
4,5 bar	31	1,8m @ 15,5m	4m @ 16,4m
	32	1,8m @ 15,5m	3,4m @ 19,5m
	33	2,1m @ 18m	4m @ 20,7m
	34	2,4m @ 19m	4,6m @ 22,6m
	35	2,7m @ 20m	4,6m @ 23m
5,5 bar	36	2,4m @ 22,9m	5,5m @ 25,3m
	37	2,7m @ 22,5m	5,8m @ 25m

INF35 Nozzle Apex—(U.S.)

Pressure	Nozzle	Apex at 15°	Apex at 25°
65 PSI	31	6' @ 51'	13' @ 54'
	32	6' @ 51'	11' @ 64'
	33	7' @ 59'	13' @ 68'
	34	8' @ 63'	15' @ 74'
	35	9' @ 66'	15' @ 76'
80 PSI	36	8' @ 75'	18' @ 83'
	37	9' @ 74'	19' @ 82'



INFINITY® SERIES GOLF ROTORS INF35/INF55

INF55 Performance Data—25° – (Metric)

Front Nozzle Positions	Nozzle Set 51 (Yellow)		Nozzle Set 52 (Blue)		Nozzle Set 53 (Brown)		Nozzle Set 54 (Orange)		Nozzle Set 55 (Green)		Nozzle Set 56 (Gray)		Nozzle Set 57 (Black)		Nozzle Set 58 (Red)		Nozzle Set 59 (Beige)			
	102-6906		102-0726		102-6907		102-0728		102-6955		102-6935		102-6936		102-6909		102-4259			
	Yellow	Brown	Yellow	Yellow	Yellow	Yellow	Yellow	Yellow	Yellow	Yellow	Green	Green	Green	Green	Green	Green	Green	Green	Green	Green
102-5670		102-5671		102-5670		102-6884		102-5670		102-6884		102-5670		102-6885		102-6531		102-6885		
Back Nozzle Positions																				
Red Plug		Red Plug		Red Plug		Red Plug		Red Plug		Red Plug		Red Plug		Red Plug		Red Plug		Red Plug		
102-4335		102-4335		102-4335		102-4335		102-4335		102-4335		102-4335		102-4335		102-4335		102-4335		
Bar	kPa	kg/cm2	Radius	LPM	Radius	LPM	Radius	LPM	Radius	LPM	Radius	LPM	Radius	LPM	Radius	LPM	Radius	LPM	Radius	LPM
3,4	340	3,47	16,7	53,4	17,3	70,0	18,9	84,4	20,1	97,6	—	—	—	—	—	—	—	—	—	—
4,5	450	4,59	17,4	59,8	18,2	79,1	19,8	95,0	21,0	108,6	22,3	135,8	—	—	—	—	—	—	—	—
5,5	550	5,61	18,0	66,2	18,5	87,4	20,7	105,2	21,9	119,9	23,1	150,3	24,4	163,2	25,2	182,5	25,9	189,3	27,1	217,6
6,9	690	7,04	18,6	73	19,2	95,7	21,7	114,7	22,8	130,6	24,4	164,6	25,2	185,5	26,8	194,9	27,4	204,0	28,0	232,0

INF55 Series Performance Chart—15°

Bar	kPa	kg/cm2	Radius	LPM	Radius	LPM	Radius	LPM	Radius	LPM	Radius	LPM	Radius	LPM	Radius	LPM	Radius	LPM	Radius	LPM
3,4	340	3,47	16,7	53,0	17,9	62,5	18,9	84,0	19,2	96,9	—	—	—	—	—	—	—	—	—	—
4,5	450	4,59	17,1	59,0	18,8	78,3	19,8	94,6	20,1	107,9	22,8	133,6	—	—	—	—	—	—	—	—
5,5	550	5,61	18,0	65,9	20,1	87,1	21,0	104,8	21,4	119,2	23,1	147,6	23,7	160,5	24,0	177,5	24,0	187,4	25,0	216,5
6,9	690	7,04	18,2	72,7	20,7	95,0	21,7	114,3	22,0	129,8	24,4	158,6	24,6	184,3	25,3	192,2	25,3	202,1	25,9	230,1
Stator			102-1939 Yellow								102-1940 White								102-1941 White	
Conversions			INF55-5154								INF55-5558								INF55-59	

INF55 Performance Data—25° – (U.S.)

Front Nozzle Positions	Nozzle Set 51 (Yellow)		Nozzle Set 52 (Blue)		Nozzle Set 53 (Brown)		Nozzle Set 54 (Orange)		Nozzle Set 55 (Green)		Nozzle Set 56 (Gray)		Nozzle Set 57 (Black)		Nozzle Set 58 (Red)		Nozzle Set 59 (Beige)			
	102-6906		102-0726		102-6907		102-0728		102-6955		102-6935		102-6936		102-6909		102-4259			
	Yellow	Brown	Yellow	Yellow	Yellow	Yellow	Yellow	Yellow	Yellow	Yellow	Green	Green	Green	Green	Green	Green	Green	Green	Green	Green
102-5670		102-5671		102-5670		102-6884		102-5670		102-6885		102-6531		102-6885		102-6531		102-6885		
Back Nozzle Positions																				
Red Plug		Red Plug		Red Plug		Red Plug		Red Plug		Red Plug		Red Plug		Red Plug		Red Plug		Red Plug		
102-4335		102-4335		102-4335		102-4335		102-4335		102-4335		102-4335		102-4335		102-4335		102-4335		
PSI	Radius	GPM	Radius	GPM	Radius	GPM	Radius	GPM	Radius	GPM	Radius	GPM	Radius	GPM	Radius	GPM	Radius	GPM	Radius	GPM
50	55	14.1	57	18.5	62	22.3	66	25.8	—	—	—	—	—	—	—	—	—	—	—	—
65	57	15.8	60	20.9	65	25.1	69	28.7	73	35.9	—	—	—	—	—	—	—	—	—	—
80	59	17.5	61	23.1	68	27.8	72	31.7	76	39.7	80	43.1	83	48.2	85	50.0	89	57.5	—	—
100	61	19.3	63	25.3	71	30.3	75	34.5	80	43.5	83	49.0	88	51.5	90	53.9	92	61.3	—	—

INF55 Series Performance Chart—15°

PSI	Radius	GPM	Radius	GPM	Radius	GPM	Radius	GPM	Radius	GPM	Radius	GPM	Radius	GPM	Radius	GPM	Radius	GPM	Radius	GPM
50	55	14.0	59	16.5	62	22.2	63	25.6	—	—	—	—	—	—	—	—	—	—	—	—
65	56	15.6	62	20.7	65	25.0	66	28.5	75	35.3	—	—	—	—	—	—	—	—	—	—
80	59	17.4	66	23.0	69	27.7	70	31.5	78	39.0	78	42.4	79	46.9	79	49.5	82	57.2	—	—
100	60	19.2	68	25.1	71	30.2	72	34.3	80	41.9	81	47.2	83	52.1	83	53.4	85	60.8	—	—
Stator			102-1939 Yellow								102-1940 White								102-1941 White	
Conversions			INF55-5154								INF55-5558								INF55-59	

■ Not recommended at these pressures.

Toro recommends the use of a 1 1/4" swing joint at flows over 25-GPM (95-LPM). Sprinkler radius of throw per ASAE standard S398.1.

All sprinklers are equipped with the selectable pilot valve that allows settings at 3.4, 4.5, 5.5, and 6.9 Bar (50, 65, 80 and 100 psi).

INF55 Nozzle Apex—(Metric)

Pressure	Nozzle	Apex at 15°	Apex at 25°
4,5 bar	51	1,8m @ 15,5m	4m @ 16,4m
	52	1,8m @ 15,5m	3,4m @ 19,5m
	53	2,1m @ 18m	4m @ 20,7m
	54	2,4m @ 19m	4,6m @ 22,6m
	55	2,7m @ 20m	4,6m @ 23m
5,5 bar	56	2,4m @ 22,9m	5,5m @ 25,3m
	57	2,7m @ 22,5m	5,8m @ 25m
	58	3m @ 25m	5,5m @ 26,5m
	59	3,4m @ 24,6m	6,4m @ 27,7m

INF55 Nozzle Apex—(U.S.)

Pressure	Nozzle	Apex at 15°	Apex at 25°
65 PSI	51	6' @ 51'	13' @ 54'
	52	6' @ 51'	11' @ 64'
	53	7' @ 59'	13' @ 68'
	54	8' @ 63'	15' @ 74'
	55	9' @ 66'	15' @ 76'
80 PSI	56	8' @ 75'	18' @ 83'
	57	9' @ 74'	19' @ 82'
	58	10' @ 82'	18' @ 87'
	59	11' @ 81'	21' @ 91'



INFINITY® SERIES GOLF ROTORS INF34/INF54



Learn more at toroinfinity.com



The INFINITY 34/54 is Toro's Premium full-circle golf sprinkler series with Smart Access.

The dual trajectory main nozzle provides exceptional nozzle performance at the 25° standard angle position and great performance in windy applications at the 15° low angle position. And the consistency of the constant velocity full circle drive ensures even water application across the coverage area every time you water.

Features & Benefits



Specifications



Performance Data



SMART ACCESS provides top accessibility to all critical components and room to grow for whatever the future holds.



Dual Trajectory - 25° or 15°
Provides two selections for the main nozzle trajectory; the 25 degree setting provides maximum distance of throw and the 15 degree setting provides improved wind performance, radius reduction and obstacle avoidance.





INFINITY® SERIES GOLF ROTORS INF34/INF54

Features & Benefits

- ① **Industry's Largest Nozzle Selection**
Nozzles from 15,9m - 30,2m (52' to 99'). Color coded for easy flow and radius identification and threaded from the front to simplify servicing.
- ② **Five Activation types**
 - Standard solenoid
 - Spike Guard™ solenoid
 - Nickel plated Spike Guard solenoid
 - DC Latching solenoid (DCLS)
 - Integrated GDC module w/ DCLS available on all INFINITY models!

- ③ **Constant Velocity Full Circle Drive**
Ensures consistent rotation speeds when matched with station run times for even water application across the coverage area every time you water.
- ④ **Radius Reduction Screw for Fine Tuning**
In combination with main nozzle sizing and trajectory adjustment the radius reduction screw can effectively reduce the sprinkler throw down to 9,1m (30').



INFINITY® SERIES GOLF ROTORS INF34/INF54



INF34 Conversion Upgrades

Models	Description
INF34-3134	INF34 w/31-34 Nozzles (33 Nozzle Installed)
INF34-3537	INF34 w/35-37 Nozzles (35 Nozzle Installed)



INF54 Conversion Upgrades

Models	Description
INF54-5154	INF54 w/51-54 Nozzles (53 Nozzle Installed)
INF54-5558	INF54 w/55-58 Nozzles (55 Nozzle Installed)
INF54-59	INF54 w/ 59 Nozzle installed



Features

Dual Trajectory adjustment on main nozzle - 25° or 15°
 Constant velocity full circle drive
 Radius reduction screw can effectively reduce the sprinkler throw down to 30'

Operating Specifications

Inlet:

- **INF34:** 25mm (1") ACME
- **INF54:** 40mm (1.5") ACME

Radius:

- **INF34:** 15,9 – 27,8m (52' – 91')
- **INF54:** 15,9 – 30,2m (52' – 99')

Flow Rate:

- **INF34:** 49,2-177,5 LPM (13.0 – 46.9 GPM)
- **INF54:** 50,0-233,9 LPM (13.2 – 61.8 GPM)

Precipitation Rates:

- **INF34:** Minimum: 8,4 mm/hr (0.33"/hr)
 Maximum: 13,9 mm/hr (0.55"/hr)
- **INF54:** Minimum: 8,4 mm/hr (0.33"/hr)
 Maximum: 15,5 mm/hr (0.61"/hr)

Pilot Valve: Selectable at 3,5; 4,5; 5,5; and 6,9 Bar (50, 65, 80 and 100 psi)

Recommended Operating Pressure Range:

- 4,5-6,9 Bar (65-100 psi)
- Maximum: 10,3 Bar (150 psi)
- Minimum: 2,8 Bar (40 psi)

Activation Type

- Standard Solenoid
- Spike Guard Solenoid
- Nickel-plated Spike Guard Solenoid
- DC Latching Solenoid (DCLS)
- Integrated GDC Module w/DCLS

Trajectory: 25° or 15°

Dimensions

SMART ACCESS® Cover And Compartment Diameter:

- **INF34:** 19cm (7.5")
- **INF54:** 19cm (7.5")

Body height:

- **INF34:** 25cm (10")
- **INF54:** 29cm (11.38")

Weight:

- **INF34:** 1,91kg (4.22 lbs.)
- **INF54:** 2,28kg (5.04 lbs.)

Pop-up height to nozzle: 8,25cm (3.25")

Warranty

Two years; Five years when installed with Toro Swing Joints



Specifying Information—INF34 & INF54

INFX4-XXX-XX					
Body Inlet	Arc	Nozzle	Pressure Regulation*	Activation Type	Trajectory
INFX	4	XX	X	X	6
3—1" 5—1½"	4—Full Circle	INF34—31, 32, 33, 34, 35, 36, 37 INF54—51, 52, 53, 54, 55, 56, 57, 58, 59	6— 4,5 bar (65 psi) 8— 5,5 bar (80 psi) 1— 6,9 bar (100 psi)	1—Standard Solenoid 2—Spike Guard™ Solenoid 3—Nickel-plated Spike Guard Solenoid 4—DC Latching Solenoid (DCLS) 5—Integrated GDC Module w/DCLS	6—24-position TruJectory
Example: When specifying an INF34 Series Sprinkler with #34 nozzle, pressure regulation at 4,5 bar (65 psi) and Spike Guard you would specify: INF34-346-2					

* All sprinklers are equipped with the selectable pilot valve that allows settings at 3,4; 4,5; 5,5; and 6,9 Bar (50, 65, 80 and 100 psi).
 Note: Not all models available.



INFINITY® SERIES GOLF ROTORS INF34/INF54

INF34 Series Performance Chart—25° (Metric)

Front Nozzle Positions			Nozzle Set 31 (Yellow)		Nozzle Set 32 (Blue)		Nozzle Set 33 (Brown)		Nozzle Set 34 (Orange)		Nozzle Set 35 (Green)		Nozzle Set 36 (Gray)		Nozzle Set 37 (Black)			
			102-0725		102-7001		102-0727		102-7002		102-6908		102-0730		102-4261			
			Red Plug	Red Plug	Red Plug	Red Plug	Red Plug	Red Plug	Red Plug	Red Plug	Red Plug	Red Plug	Red Plug	Red Plug	Red Plug	Red Plug	Red Plug	Brown
102-4335	102-4335	102-4335	102-4335	102-4335	102-4335	102-4335	102-4335	102-4335	102-4335	102-4335	102-4335	102-4335	102-4335	102-4335	102-6883			
Back Nozzle Positions																		
			Yellow	Blue	Yellow	Orange	Yellow	Red	Yellow	Beige	Yellow	Beige	Yellow	Red	Yellow	Gray		
			102-6937	102-2925	102-6937	102-2926	102-6937	102-2928	102-6937	102-2929	102-6937	102-2929	102-6937	102-2929	102-6937	102-6944	102-6937	102-6945
Bar	kPa	kg/cm ²	Radius	LPM	Radius	LPM	Radius	LPM	Radius	LPM	Radius	LPM	Radius	LPM	Radius	LPM		
3,4	340	3,47	17,4	49,2	17,7	58,7	19,5	82,9	20,7	92,4	—	—	—	—	—	—		
4,5	450	4,59	17,7	55,3	18,3	68,1	20,7	92,4	22,0	106,4	23,2	121,9	—	—	—	—		
5,5	550	5,61	18,3	61,3	19,2	77,6	22,0	101,8	23,2	117,7	24,4	134,7	25,3	144,6	25,9	157,1		
6,9	690	7,04	18,9	67,8	20,1	88,6	22,9	112,8	24,1	132,1	25,6	148,8	26,8	164,3	27,8	177,5		

INF34 Series Performance Chart—15°

Bar	kPa	kg/cm ²	Radius	LPM	Radius	LPM	Radius	LPM	Radius	LPM	Radius	LPM	Radius	LPM	Radius	LPM	
3,4	340	3,47	15,9	48,8	16,2	59,0	18,3	82,1	18,9	96,5	—	—	—	—	—	—	
4,5	450	4,59	16,2	54,5	16,5	64,7	18,6	91,6	19,5	106,0	20,4	121,5	—	—	—	—	
5,5	550	5,61	17,1	60,6	17,4	71,9	19,8	100,7	21,0	117,3	22,3	134,4	23,2	143,8	23,5	156,3	
6,9	690	7,04	17,4	66,2	18,0	77,6	20,4	111,7	21,7	128,3	22,9	145,3	24,4	163,1	24,7	177,1	
Stator			102-6929 Blue									102-1940 White					
Conversions			INF34-3134									INF34-3537					

INF34 Series Performance Chart—25° (U.S.)

Front Nozzle Positions			Nozzle Set 31 (Yellow)		Nozzle Set 32 (Blue)		Nozzle Set 33 (Brown)		Nozzle Set 34 (Orange)		Nozzle Set 35 (Green)		Nozzle Set 36 (Gray)		Nozzle Set 37 (Black)			
			102-0725		102-7001		102-0727		102-7002		102-6908		102-0730		102-4261			
			Red Plug	Red Plug	Red Plug	Red Plug	Red Plug	Red Plug	Red Plug	Red Plug	Red Plug	Red Plug	Red Plug	Red Plug	Red Plug	Red Plug	Red Plug	Brown
102-4335	102-4335	102-4335	102-4335	102-4335	102-4335	102-4335	102-4335	102-4335	102-4335	102-4335	102-4335	102-4335	102-4335	102-4335	102-6883			
Back Nozzle Positions																		
			Yellow	Blue	Yellow	Orange	Yellow	Red	Yellow	Beige	Yellow	Beige	Yellow	Red	Yellow	Gray		
			102-6937	102-2925	102-6937	102-2926	102-6937	102-2928	102-6937	102-2929	102-6937	102-2929	102-6937	102-2929	102-6937	102-6944	102-6937	102-6945
PSI	Radius	GPM	Radius	GPM	Radius	GPM	Radius	GPM	Radius	GPM	Radius	GPM	Radius	GPM	Radius	GPM		
50	57	13.0	58	15.5	64	21.9	68	24.4	—	—	—	—	—	—	—	—		
65	58	14.6	60	18.0	68	24.4	72	28.1	76	32.2	—	—	—	—	—	—		
80	60	16.2	63	20.5	72	26.9	76	31.1	80	35.6	83	38.2	85	41.5	—	—		
100	62	17.9	66	23.4	75	29.8	79	34.9	84	39.3	88	43.4	91	46.9	—	—		
Stator			102-6929 Blue									102-1940 White						
Conversions			INF34-3134									INF34-3537						

INF34 Series Performance Chart—15°

psi	Radius	GPM	Radius	GPM	Radius	GPM	Radius	GPM	Radius	GPM	Radius	GPM	Radius	GPM	Radius	GPM	
50	52	12.9	53	15.6	60	21.7	62	25.5	—	—	—	—	—	—	—	—	
65	53	14.4	54	17.1	61	24.2	64	28.0	67	32.1	—	—	—	—	—	—	
80	56	16.0	57	19.0	65	26.6	69	31.0	73	35.5	76	38.0	77	41.3	—	—	
100	57	17.5	59	20.5	67	29.5	71	33.9	75	38.4	80	43.1	81	46.8	—	—	
Stator			102-6929 Blue									102-1940 White					
Conversions			INF34-3134									INF34-3537					

■ Not recommended at these pressures. Radius shown in feet.
 Toro recommends the use of a 1 1/4" swing joint at flows over 25-GPM (95-LPM). Sprinkler radius of throw per ASAE standard S398.1.
 All sprinklers are equipped with the selectable pilot valve that allows settings at 3,4; 4,5; 5,5; and 6,9 Bar (50, 65, 80 and 100 psi).

INF34 Nozzle Apex—(Metric)

Pressure	Nozzle	Apex at 15°	Apex at 25°
4,5 bar	31	1,8 @ 15,6	4,0 @ 16,5
	32	1,8 @ 15,6	3,4 @ 19,5
	33	2,1 @ 18,0	4,0 @ 20,7
	34	2,4 @ 19,2	4,6 @ 22,6
	35	2,7 @ 20,1	4,6 @ 23,2
5,5 bar	36	2,4 @ 22,9	5,5 @ 25,3
	37	2,7 @ 22,6	5,8 @ 25,0

INF34 Nozzle Apex—(U.S.)

Pressure	Nozzle	Apex at 15°	Apex at 25°
65 PSI	31	6' @ 51'	13' @ 54'
	32	6' @ 51'	11' @ 64'
	33	7' @ 59'	13' @ 68'
	34	8' @ 63'	15' @ 74'
	35	9' @ 66'	15' @ 76'
80 PSI	36	8' @ 75'	18' @ 83'
	37	9' @ 74'	19' @ 82'



INFINITY® SERIES GOLF ROTORS INF34/INF54

INF54 Series Performance Chart—25° (Metric)

			Nozzle Set 51 (Yellow) 102-0725		Nozzle Set 52 (Blue) 102-7001		Nozzle Set 53 (Brown) 102-0727		Nozzle Set 54 (Orange) 102-7002		Nozzle Set 55 (Green) 102-6908		Nozzle Set 56 (Gray) 102-0730		Nozzle Set 57 (Black) 102-4261		Nozzle Set 58 (Red) 102-4260		Nozzle Set 59 (Beige) 102-4259			
Front Nozzle Positions																						
	102-4335	102-4335	102-4335	102-4335	102-4335	102-4335	102-4335	102-4335	102-4335	102-4335	102-4335	102-4335	102-4335	102-4335	102-4335	102-4335	102-4335	102-4335	102-4335	102-4335	102-4335	102-4335
		102-6937	102-2925	102-6937	102-2926	102-6937	102-2928	102-6937	102-2929	102-6937	102-2929	102-6937	102-6944	102-6937	102-6945	102-6937	102-6945	102-6937	102-6945	102-6937	102-6945	102-6937
Bar	kPa	kg/cm ²	Radius	LPM	Radius	LPM	Radius	LPM	Radius	LPM	Radius	LPM	Radius	LPM	Radius	LPM	Radius	LPM	Radius	LPM	Radius	LPM
3,4	340	3,47	17,7	50,0	18,0	59,4	19,5	83,3	21,4	99,2	-	-	-	-	-	-	-	-	-	-	-	-
4,5	450	4,59	18,3	56,0	18,6	66,2	20,7	93,9	22,6	110,9	24,1	129,4	-	-	-	-	-	-	-	-	-	-
5,5	550	5,61	18,6	62,1	19,5	75,7	22,0	104,5	23,8	123,4	25,3	143,8	25,9	154,0	26,5	169,9	27,8	190,0	29,3	210,4	-	-
6,9	690	7,04	19,2	68,5	20,4	89,3	22,9	115,1	24,7	138,9	26,5	160,9	27,5	173,4	28,4	190,0	29,0	209,7	30,2	233,9	-	-

INF54 Series Performance Chart—15°

Bar	kPa	kg/cm ²	Radius	LPM	Radius	LPM	Radius	LPM	Radius	LPM	Radius	LPM	Radius	LPM	Radius	LPM	Radius	LPM	Radius	LPM	Radius	LPM	
3,4	340	3,47	15,9	50,0	16,2	59,8	18,6	83,3	19,8	98,4	-	-	-	-	-	-	-	-	-	-	-	-	
4,5	450	4,59	16,2	56,0	16,5	65,9	19,2	93,9	20,4	110,5	21,0	129,1	-	-	-	-	-	-	-	-	-	-	
5,5	550	5,61	17,1	62,1	17,7	73,4	20,7	104,5	22,0	123,0	22,9	143,1	24,1	152,9	24,7	168,8	25,9	188,9	26,5	209,3	-	-	
6,9	690	7,04	17,7	68,5	18,3	79,9	21,7	115,1	22,9	137,8	24,1	160,1	25,6	172,2	26,5	188,9	27,1	208,6	28,7	232,8	-	-	
Stator			102-6929 Blue									102-1940 White									102-1941 White		
Conversions			INF54-5154									INF54-5558									INF54-59		

INF54 Series Performance Chart—25° (U.S.)

			Nozzle Set 51 (Yellow) 102-0725		Nozzle Set 52 (Blue) 102-7001		Nozzle Set 53 (Brown) 102-0727		Nozzle Set 54 (Orange) 102-7002		Nozzle Set 55 (Green) 102-6908		Nozzle Set 56 (Gray) 102-0730		Nozzle Set 57 (Black) 102-4261		Nozzle Set 58 (Red) 102-4260		Nozzle Set 59 (Beige) 102-4259			
Front Nozzle Positions																						
	102-4335	102-4335	102-4335	102-4335	102-4335	102-4335	102-4335	102-4335	102-4335	102-4335	102-4335	102-4335	102-4335	102-4335	102-4335	102-4335	102-4335	102-4335	102-4335	102-4335	102-4335	102-4335
		102-6937	102-2925	102-6937	102-2926	102-6937	102-2928	102-6937	102-2929	102-6937	102-2929	102-6937	102-6944	102-6937	102-6945	102-6937	102-6945	102-6937	102-6945	102-6937	102-6945	102-6937
PSI	Radius	GPM	Radius	GPM	Radius	GPM	Radius	GPM	Radius	GPM	Radius	GPM	Radius	GPM	Radius	GPM	Radius	GPM	Radius	GPM	Radius	GPM
50	58	13,2	59	15,7	64	22,0	70	26,2	-	-	-	-	-	-	-	-	-	-	-	-	-	-
65	60	14,8	61	17,5	68	24,8	74	29,3	79	34,2	-	-	-	-	-	-	-	-	-	-	-	-
80	61	16,4	64	20,0	72	27,6	78	32,6	83	38,0	85	40,7	87	44,9	91	50,2	96	55,6	-	-	-	-
100	63	18,1	67	23,6	75	30,4	81	36,7	87	42,5	90	45,8	93	50,2	95	55,4	99	61,8	-	-	-	-

INF54 Series Performance Chart—15°

psi	Radius	GPM	Radius	GPM	Radius	GPM	Radius	GPM	Radius	GPM	Radius	GPM	Radius	GPM	Radius	GPM	Radius	GPM	Radius	GPM	Radius	GPM	
50	52	13,2	53	15,8	61	22,0	65	26,0	-	-	-	-	-	-	-	-	-	-	-	-	-	-	
65	53	14,8	54	17,4	63	24,8	67	29,2	69	34,1	-	-	-	-	-	-	-	-	-	-	-	-	
80	56	16,4	58	19,4	68	27,6	72	32,5	75	37,8	79	40,4	81	44,6	85	49,9	87	55,3	-	-	-	-	
100	58	18,1	60	21,1	71	30,4	75	36,4	79	42,3	84	45,5	87	49,9	89	55,1	94	61,5	-	-	-	-	
Stator			102-6929 Blue									102-1940 White									102-1941 White		
Conversions			INF54-5154									INF54-5558									INF54-59		

■ Not recommended at these pressures. Radius shown in feet.

Toro recommends the use of a 1 1/4" swing joint at flows over 25-GPM (95-LPM). Sprinkler radius of throw per ASAE standard S398.1. All sprinklers are equipped with the selectable pilot valve that allows settings at 3,4; 4,5; 5,5; and 6,9 Bar (50, 65, 80 and 100 psi).

INF54 Nozzle Apex—(Metric)

Pressure	Nozzle	Apex at 15°	Apex at 25°
4,5 Bar	51	1,8 @ 15,6	4,0 @ 16,5
	52	1,8 @ 15,6	3,4 @ 19,5
	53	2,1 @ 18,0	4,0 @ 20,7
	54	2,4 @ 19,2	4,6 @ 22,6
	55	2,7 @ 20,1	4,6 @ 23,2
5,5 Bar	56	2,4 @ 22,9	5,5 @ 25,3
	57	2,7 @ 22,6	5,8 @ 25,0
	58	3,0 @ 25,0	5,5 @ 26,5
	59	3,4 @ 24,7	6,4 @ 27,1

INF54 Nozzle Apex—(U.S.)

Pressure	Nozzle	Apex at 15°	Apex at 25°
65 PSI	51	6' @ 51'	13' @ 54'
	52	6' @ 51'	11' @ 64'
	53	7' @ 59'	13' @ 68'
	54	8' @ 63'	15' @ 74'
	55	9' @ 66'	15' @ 76'
80 PSI	56	8' @ 75'	18' @ 83'
	57	9' @ 74'	19' @ 82'
	58	10' @ 82'	18' @ 87'
	59	11' @ 81'	21' @ 91'



FLEX800™ SERIES GOLF ROTORS FLX35-6/FLX55-6



Learn more at
Toro.com



Features & Benefits



Specifications



Performance Data



FLEX800™ 35-6/55-6 Series

With the industry's largest selection of high performance nozzles and TruJectory™ adjustment the NEW FLEX800™ 35-6/55-6 Series allows you to put water precisely where you want it for maximum distribution uniformity. The part/full circle drive allows you to simply and economically adjust the area of coverage to match your seasonal watering needs or meet water rationing mandates in seconds with no disassembly or additional parts required. Finally, with TruJectory™ you have 24 positions from 7 to 30° in 1° increments to put water where you want it.

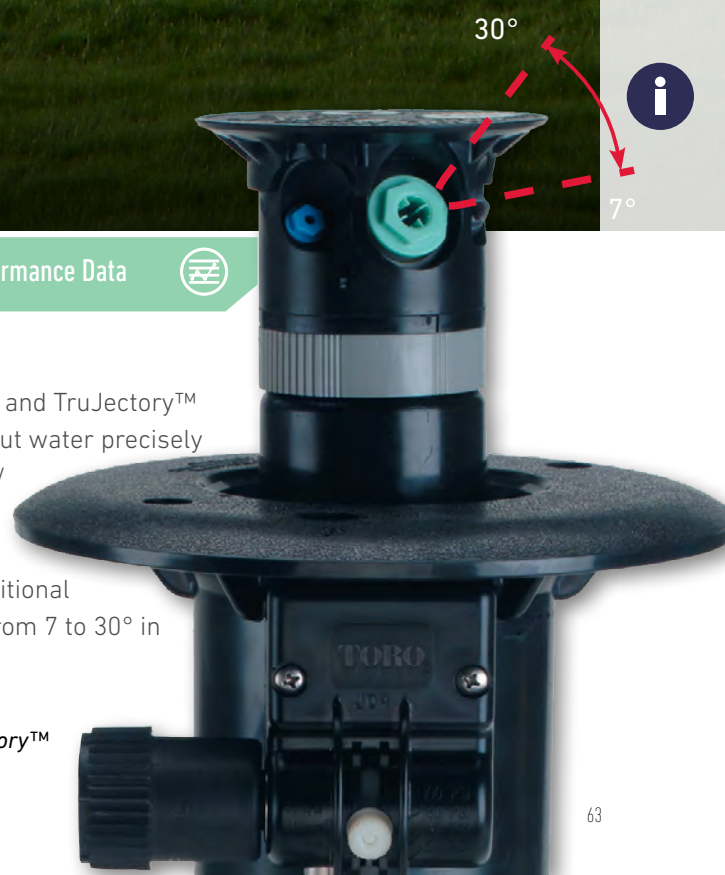

TruJectory™





FLEX800™ SERIES GOLF ROTORS FLX35-6/FLX55-6

Features & Benefits

- ① **Industry's Largest Nozzle Selection**
Nozzles from 12,8m – 30,5m (42' to 100') radius plus a wide assortment of back nozzles lets you put the precise amount of water exactly where you need it. All nozzles threaded in from the front. All nozzles threaded in from the front.
- ② **20,000 Volt Lightning Rating**
Spike-Guard™ solenoid virtually eliminates the need for replacements in high lightning areas. Draws half the amperage of traditional solenoids so you can run twice as many sprinklers simultaneously, reduce the cost of wire during initial installation or increase the distance from controller to sprinkler.



- ③ **Adjustment With No Disassembly**
Toro exclusive, simply pull up the riser and ratchet it to the precise position you want to water.
- ④ **True Part- and Full-Circle in One (40° - 330° part circle)**
These sprinklers can be full circle today and part circle tomorrow allowing you to simply and economically adjust the area of coverage to match your seasonal needs or meet water rationing mandates.



Industry's Largest Nozzle Selection



Spike Guard™ Solenoid



Ratcheting Riser



True Part and Full-Circle in One

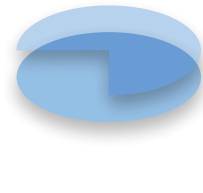
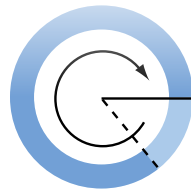

FLEX800™ SERIES GOLF ROTORS FLX35-6/FLX55-6



Conversion Upgrades

FLX35-6 Conversion Upgrades

Models	Description
• FLX35-6-3134	FLX35-6 w/31–34 Nozzles (33 Nozzle Installed)
• FLX35-6-3537	FLX35-6 w/35–37 Nozzles (35 Nozzle Installed)



FLX55-6 Conversion Upgrades—(Ribbed Body)

Models	Description
• FLX55-6-5154	FLX55-6 w/51–54 Nozzles (53 Nozzle Installed)
• FLX55-6-5558	FLX55-6 w/55–58 Nozzles (55 Nozzle Installed)
• FLX55-6-59	FLX55-6 w/59 Nozzle



FLX55-6 Conversion Upgrades—(Ribless Body)

Models	Description
• FLX55-6-5154R	FLX55-6 w/51–54 Nozzles (53 Nozzle Installed)
• FLX55-6-5558R	FLX55-6 w/55–58 Nozzles (55 Nozzle Installed)
• FLX55-6-59R	FLX55-6 w/59 Nozzle



Specifications

Features

- Trajectory: 24 positions from 7° – 30° in 1° increments
- Part/Full circle sprinklers
- Pop-up height to nozzle: 8,25cm (3.25")

Operating Specifications

Inlet:

- FLX35-6: 25mm (1") ACME
- FLX55-6: 40mm (1.5") ACME

Radius:

- FLX35-6: 12,8 – 28,0m (42' – 92')
- FLX55-6: 15,9 – 30,5m (52' – 100')

Flow Rate:

- FLX35-6: 26,9-171,5 LPM (7.1 – 45.3 GPM)
- FLX55-6: 52,6-231,3 LPM (13.9 – 61.1 GPM)

Precipitation Rates:

- FLX35-6: Minimum: 9mm/hr (0.37"/hr);
Maximum: 13,5mm/hr (0.53"/hr)
- FLX55-6: Minimum: 11mm/hr (0.43"/hr);
Maximum: 15mm/hr (0.60"/hr)

Pilot Valve: Selectable at 3,4; 4,5; 5,5; and 6,9 Bar (50, 65, 80 and 100 psi)

Recommended Operating Pressure Range:

- 4,5-6,9 Bar (65-100 psi)
- Maximum: 10,3 Bar (150 psi)
- Minimum: 2,8 Bar (40 psi)

Activation types – Electric Valve-in-Head:

- Standard Solenoid:

- 24 VAC, 50/60 Hz
- Inrush: 0.30 A
- Holding 0.20 A

- Spike Guard Solenoid:

- 24 VAC, 50/60 Hz
- Inrush: 0.12 A
- Holding 0.10 A

- Nickel-Plated Spike Guard Solenoid:

- 24 VAC, 50/60 Hz
- Inrush: 0.12 A
- Holding 0.10 A

- DC Latching Solenoid (DCLS):

- 12 VDC pulse or latching pulse

- Integrated GDC Module w/DCLS:

- 12 VDC pulse or latching pulse

Nozzle Selection

- FLX35-6 has eight nozzle variation (30, 31, 32, 33, 34, 35, 36 & 37)
- FLX55-6 has nine nozzle variations (51, 52, 53, 54, 55, 56, 57, 58 & 59)
- Four in-line nozzles, rotating stream pattern
- One back nozzle position

Dimensions

- Body diameter:
 - FLX35-6: 16,5cm (6.5")
 - FLX55-6: 19cm (7.5")
- Body height:
 - FLX35-6: 25cm (10")
 - FLX55-6: 29cm (11.38")
- Weight:
 - FLX35-6: 1,35kg (2.98 lbs.)
 - FLX55-6: 1,68kg (3.70 lbs.)

Warranty

- Two years; Five years when installed with Toro Swing Joints

Specifying Information—FLX35-6 & FLX55-6

FLX5-XXX-X6					
Body Inlet	Arc	Nozzle	Pressure Regulation*	Activation Type	Trajectory
FLXX	X	XX	X	X	6
3— 25mm (1") 5— 40mm (1.5")	5—Part-circle and Full-circle In One	FLX35 - 30 31 32 33 34 35 36 37 FLX55 - 51 52 53 54 55 56 57 58 59	6— 4,5 bar (65 psi) 8— 5,5 bar (80 psi) 1— 6,9 bar (100 psi)	1—Standard Solenoid 2—Spike Guard™ Solenoid 3—Nickel-plated Spike Guard Solenoid 4—DC Latching Solenoid (DCLS) 5—Integrated GDC Module w/DCLS	6—24-position TruJectory
Example: When specifying an FLX35-6 Series Sprinkler with Spike Guard™ Solenoid, #34 nozzle, an electric valve and pressure regulation at 4,5 bar (65 psi) you would specify: FLX35-346-26					

* Electric models only. All sprinklers are equipped with the selectable pilot valve that allows settings at 3,4; 4,5; 5,5; and 6,9 Bar (50, 65, 80 and 100 psi).

Note: Not all models available. Nickel-plated, corrosion-resistant models are available upon request.



FLEX800™ SERIES GOLF ROTORS FLX35-6/FLX55-6

FLX35-6/FLX55-6 Trajectory Performance—(Metric)

Nozzle/Bar/LPM	#31/51 Nozzle @ 4,5 Bar							#32/52 Nozzle @ 4,5 Bar															
	7°	10°	15°	20°	25°	30°	7°	10°	15°	20°	25°	30°											
Trajectory	7°	10°	15°	20°	25°	30°	7°	10°	15°	20°	25°	30°											
"A" Radius	14,0	14,0	15,2	15,5	16,2	16,5	15,2	14,0	14,9	14,9	15,2	15,5	16,8	19,2	19,5	16,5	19,8						
"B" Spray Height	1,2	1,2	1,5	1,8	2,4	3,0	3,4	4,0	4,0	4,6	0,9	1,2	1,2	1,8	2,7	3,7	3,4	4,6	4,0				
"C" Distance from Head	7,6	7,9	7,6	8,2	7,9	9,8	10,1	11,6	10,1	12,2	10,1	12,4	6,1	6,7	7,3	7,9	8,5	9,4	10,4	10,7	10,4	10,4	9,1

Nozzle/Bar/LPM	#33/53 Nozzle @ 4,5 Bar						#34/54 Nozzle @ 4,5 Bar															
	7°	10°	15°	20°	25°	30°	7°	10°	15°	20°	25°	30°										
Trajectory	7°	10°	15°	20°	25°	30°	7°	10°	15°	20°	25°	30°										
"A" Radius	16,5	17,1	18,0	18,9	20,1	20,7	18,6	17,7	18,3	19,2	20,4	22,6	21,3									
"B" Spray Height	1,2	1,5	1,5	1,8	2,1	2,7	4,0	4,6	1,2	1,5	1,2	1,8	1,8	2,4	3,4	3,0	4,3	5,2				
"C" Distance from Head	7,0	9,1	8,5	10,1	9,8	10,4	10,7	10,7	11,3	10,7	11,3	7,3	9,4	7,9	10,4	10,7	12,2	11,9	12,5	11,9	11,9	12,8

Nozzle/Bar/LPM	#35/55 Nozzle @ 4,5 Bar						#36/56 Nozzle @ 5,5 Bar													
	7°	10°	15°	20°	25°	30°	7°	10°	15°	20°	25°	30°								
Trajectory	7°	10°	15°	20°	25°	30°	7°	10°	15°	20°	25°	30°								
"A" Radius	18,0	18,6	18,9	19,5	20,1	21,3	23,2	22,6	23,5	19,5	21,9	20,7	22,2	23,2	22,9	24,4	25,0	25,6	25,9	25,0
"B" Spray Height	1,2	1,8	1,5	1,8	2,1	2,7	3,4	4,6	5,2	1,5	2,1	2,7	4,3	5,2	6,7					
"C" Distance from Head	9,1	10,4	9,8	11,0	11,0	13,1	13,1	13,7	13,1	13,7	13,1	13,7	7,6	11,6	12,2	13,7	14,9	13,7		

Nozzle/Bar/LPM	#37/57 Nozzle @ 5,5 Bar						#58 Nozzle @ 5,5 Bar											
	7°	10°	15°	20°	25°	30°	7°	10°	15°	20°	25°	30°						
Trajectory	7°	10°	15°	20°	25°	30°	7°	10°	15°	20°	25°	30°						
"A" Radius	19,8	21,9	21,0	22,6	23,8	23,5	25,0	25,3	26,2	27,1	25,6	25,9	22,9	23,5	25,3	26,5	28,0	26,8
"B" Spray Height	1,5	2,1	2,7	4,3	5,5	6,7	1,8	2,1	3,0	4,6	5,5	6,7						
"C" Distance from Head	9,1	11,9	12,5	14,0	15,2	14,0	11,6	12,2	13,1	14,3	15,8	14,6						

Nozzle/Bar/LPM	#59 Nozzle @ 5,5 Bar					
	7°	10°	15°	20°	25°	30°
Trajectory	7°	10°	15°	20°	25°	30°
"A" Radius	23,5	23,8	25,6	27,1	29,3	28,0
"B" Spray Height	2,1	2,4	3,4	4,9	6,4	7,6
"C" Distance from Head	12,8	13,4	13,7	14,3	16,2	14,9

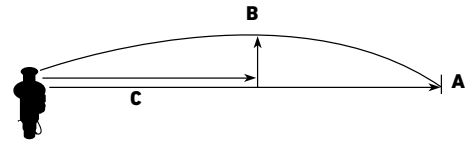

Information is for reference only, Actual results may vary.

FLX35-6 Series Performance Chart—(Metric)

Base Pressure	Nozzle Set 30		Nozzle Set 31		Nozzle Set 32		Nozzle Set 33		Nozzle Set 34		Nozzle Set 35		Nozzle Set 36		Nozzle Set 37					
	102-2208		102-4587		102-4588		102-4589		102-0728		102-0729		102-0730		102-4261					
Bar	kPa	kg/cm²	Blue	Gray	Blue	Gray	Red	Gray	Orange	Gray	Orange	Gray	Blue	Gray	Blue	Gray	Orange	Gray	Orange	Gray
Radius	LPM	Radius	LPM	Radius	LPM	Radius	LPM	Radius	LPM	Radius	LPM	Radius	LPM	Radius	LPM	Radius	LPM	Radius	LPM	
3,4	340	3,47	12,8	26,9	15,9	51,9	18,6	64,7	19,5	76,5	21,0	103,7	—	—	—	—	—	—	—	
4,5	450	4,59	13,7	32,9	16,5	58,7	19,2	77,6	20,1	86,7	22,6	113,6	23,2	122,6	—	—	—	—	—	
5,5	550	5,61	14,0	36,3	17,4	64,3	20,4	85,5	21,4	95,8	23,5	125,7	24,1	135,5	25,6	141,9	26,2	154,4		
6,9	690	7,04	14,6	42,4	18,0	71,5	22,0	95,4	22,6	106,7	24,4	140,0	25,6	151,0	26,8	160,9	28,1	171,5		
Stator			102-6929 Blue				102-1939 Yellow				102-1940 White									
Conversions			FLX35-6-3134				FLX35-6-3537													

FLX55-6 Series Performance Chart—(Metric)

Base Pressure	Nozzle Set 51		Nozzle Set 52		Nozzle Set 53		Nozzle Set 54		Nozzle Set 55		Nozzle Set 56		Nozzle Set 57		Nozzle Set 58		Nozzle Set 59			
	102-4587		102-4588		102-4589		102-0728		102-0729		102-0730		102-4261		102-4260		102-4259			
Bar	kPa	kg/cm²	Blue	Gray	Red	Gray	Orange	Gray	Orange	Gray	Blue	Gray	Blue	Gray	Orange	Gray	Blue	Gray		
Radius	LPM	Radius	LPM	Radius	LPM	Radius	LPM	Radius	LPM	Radius	LPM	Radius	LPM	Radius	LPM	Radius	LPM	Radius	LPM	
3,4	340	3,47	15,9	52,6	18,9	65,9	20,1	78,3	21,0	108,3	—	—	—	—	—	—	—	—		
4,5	450	4,59	16,5	59,4	19,5	78,3	20,7	88,6	21,6	113,1	23,2	127,9	—	—	—	—	—	—		
5,5	550	5,61	17,4	65,1	20,7	86,7	22,0	97,7	23,5	130,2	24,1	140,8	25,9	149,1	27,1	165,0	28,1	179,8	29,3	215,7
6,9	690	7,04	18,0	72,3	22,3	96,5	23,2	108,6	24,4	144,6	25,6	156,3	27,1	165,4	28,7	183,6	29,0	194,9	30,5	231,3
Stator			102-1939 Yellow				102-1940 White				102-1941									
Conversions			FLX55-6-5154				FLX55-6-5558				FLX55-6-59									

Not recommended at these pressures. Radius shown in meters. Toro recommends the use of a 30mm swing joint at flows over 95-LPM. Sprinkler radius of throw per ASAE standard S398.1. Actual site conditions must be considered when selecting the appropriate nozzle. All sprinklers are equipped with the selectable pilot valve that allows settings at 3,4; 4,5; 5,5; and 6,9 Bar.



FLEX800™ SERIES GOLF ROTORS FLX35-6/FLX55-6

FLX35-6/FLX55-6 Trajectory Performance—(U.S.)

Nozzle/PSI/GPM	#31/51 Nozzle @ 65 psi						#32/52 Nozzle @ 65 psi					
	7°	10°	15°	20°	25°	30°	7°	10°	15°	20°	25°	30°
Trajectory	7°	10°	15°	20°	25°	30°	7°	10°	15°	20°	25°	30°
"A" Radius	46'	46'	50'/51'	53'	54'	50'	46'/49'	49'/50'	51'	55'	63'/64'	54'/65'
"B" Spray Height	4'	4'	5'/6'	8'/10'	11'/13'	13'/15'	3'/4'	4'	6'	9'	12'/11'	15'/13'
"C" Distance from Head	25'/26'	25'/27'	26'/32'	33'/38'	33'/40'	33'/41'	20'/22'	24'/26'	28'/31'	34'/35'	34'	34'/30'

Nozzle/PSI/GPM	#33/53 Nozzle @ 65 psi						#34/54 Nozzle @ 65 psi					
	7°	10°	15°	20°	25°	30°	7°	10°	15°	20°	25°	30°
Trajectory	7°	10°	15°	20°	25°	30°	7°	10°	15°	20°	25°	30°
"A" Radius	54'	56'	59'	62'	66'/68'	61'	58'	60'	63'	67'	74'	70'
"B" Spray Height	4'/5'	5'/6'	7'	9'	13'	15'	4'/5'	4'/6'	6'/8'	11'/10'	14'	17'
"C" Distance from Head	23'/30'	28'/33'	32'	34'/35'	35'/37'	35'/37'	24'/31'	26'/34'	35'/40'	39'/41'	39'	39'/42'

Nozzle/PSI/GPM	#35/55 Nozzle @ 65 psi						#36/56 Nozzle @ 80 psi					
	7°	10°	15°	20°	25°	30°	7°	10°	15°	20°	25°	30°
Trajectory	7°	10°	15°	20°	25°	30°	7°	10°	15°	20°	25°	30°
"A" Radius	59'	61'/62'	64'/66'	70'	76'	74'/77'	64'/72'	68'/73'	76'/75'	80'/82'	84'/85'	82'
"B" Spray Height	4'/6'	5'/6'	7'/9'	11'	15'	17'	5'	7'	9'	14'	17'	22'
"C" Distance from Head	30'/34'	32'/36'	36'/43'	43'/45'	43'/45'	43'/45'	25'	38'	40'	45'	49'	45'

Nozzle/PSI/GPM	#37/57 Nozzle @ 80 psi						#58 Nozzle @ 80 psi					
	7°	10°	15°	20°	25°	30°	7°	10°	15°	20°	25°	30°
Trajectory	7°	10°	15°	20°	25°	30°	7°	10°	15°	20°	25°	30°
"A" Radius	65'/72'	69'/74'	78'/77'	82'/83'	86'/89'	84'/85'	75'	77'	83'	87'	92'	88'
"B" Spray Height	5'	7'	9'	14'	18'	22'	6'	7'	10'	15'	18'	22'
"C" Distance from Head	30'	39'	41'	46'	50'	46'	38'	40'	43'	47'	52'	48'

Nozzle/PSI/GPM	#59 Nozzle @ 80 psi					
	7°	10°	15°	20°	25°	30°
Trajectory	7°	10°	15°	20°	25°	30°
"A" Radius	77'	78'	84'	89'	96'	92'
"B" Spray Height	7'	8'	11'	16'	21'	25'
"C" Distance from Head	42'	44'	45'	47'	53'	49'

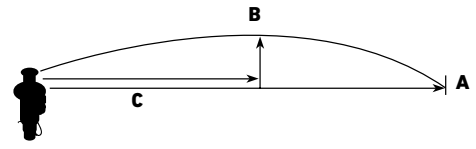

Information is for reference only. Actual results may vary.

FLX35-6 Series Performance Chart—(U.S.)

Base Pressure	Nozzle Set 30 (White)		Nozzle Set 31 (Yellow)		Nozzle Set 32 (Blue)		Nozzle Set 33 (Brown)		Nozzle Set 34 (Orange)		Nozzle Set 35 (Green)		Nozzle Set 36 (Gray)		Nozzle Set 37 (Black)							
	102-2208	102-2925	102-4587	102-2910	102-4588	102-2910	102-4589	102-2910	102-2926	102-2910	102-0728	102-2926	102-2910	102-0729	102-2925	102-2910	102-0730	102-2925	102-2910	102-4261	102-2926	102-2910
psi	Radius	GPM	Radius	GPM	Radius	GPM	Radius	GPM	Radius	GPM	Radius	GPM	Radius	GPM	Radius	GPM	Radius	GPM	Radius	GPM	Radius	GPM
50	42	7.1	52	13.7	61	17.1	64	20.2	69	27.4	—	—	—	—	—	—	—	—	—	—	—	—
65	45	8.7	54	15.5	63	20.5	66	22.9	74	30.0	76	32.4	—	—	—	—	—	—	—	—	—	—
80	46	9.6	57	17.0	67	22.6	70	25.3	77	33.2	79	35.8	84	37.5	86	40.8	—	—	—	—	—	—
100	48	11.2	59	18.9	72	25.2	74	28.2	80	37.0	84	39.9	88	42.5	92	45.3	—	—	—	—	—	—
Stator	102-6929 Blue		102-1939 Yellow						102-1940 White													
Conversions	FLX35-6-3134						FLX35-6-3537															

FLX55-6 Series Performance Chart—(U.S.)

Base Pressure	Nozzle Set 51 (Yellow)		Nozzle Set 52 (Blue)		Nozzle Set 53 (Brown)		Nozzle Set 54 (Orange)		Nozzle Set 55 (Green)		Nozzle Set 56 (Gray)		Nozzle Set 57 (Black)		Nozzle Set 58 (Red)		Nozzle Set 59 (Beige)							
	102-4587	102-2925	102-4588	102-2910	102-4589	102-2910	102-0728	102-2926	102-2910	102-0729	102-2925	102-2910	102-0730	102-2925	102-2910	102-4261	102-2925	102-2910	102-4260	102-2925	102-2910	102-4259	102-2925	102-2910
psi	Radius	GPM	Radius	GPM	Radius	GPM	Radius	GPM	Radius	GPM	Radius	GPM	Radius	GPM	Radius	GPM	Radius	GPM	Radius	GPM	Radius	GPM	Radius	GPM
50	52	13.9	62	17.4	66	20.7	69	28.6	—	—	—	—	—	—	—	—	—	—	—	—	—	—	—	—
65	54	15.7	64	20.8	68	23.4	74	31.2	76	33.8	—	—	—	—	—	—	—	—	—	—	—	—	—	—
80	57	17.2	68	22.9	72	25.8	77	34.4	79	37.2	85	39.4	89	43.6	92	47.5	96	57.0	—	—	—	—	—	—
100	59	19.1	73	25.5	76	28.7	80	38.2	84	41.3	89	43.7	94	48.5	95	51.1	100	61.1	—	—	—	—	—	—
Stator	102-1939 Yellow						102-1940 White						102-1941											
Conversions	FLX55-6-5154						FLX55-6-5558						FLX55-6-59											

Toro recommends the use of a 1.25" swing joint at flows over 25-GPM (95-LPM). Sprinkler radius data collected in Toro's zero wind test facility per ASAE standard S398.1. Actual site conditions must be considered when selecting the appropriate nozzle. Not recommended at these pressures. Radius shown in feet. All sprinklers are equipped with the selectable pilot valve that allows settings at 50, 65, 80 and 100 psi.



FLEX800™ SERIES GOLF ROTORS FLX35/FLX55



Learn more at
Toro.com



Features & Benefits



Specifications



Performance Data



The New FLEX800 35/55 Series features a dual trajectory main nozzle that provides exceptional nozzle performance at the 25° standard angle position and great performance in windy applications at the 15° low angle position. And the part/full circle drive allows you to adjust the area of coverage to match your seasonal watering needs or meet water rationing mandates in seconds with no additional parts required.

Part/Full Circle Drive

TORO.



FLEX800™ SERIES GOLF ROTORS FLX35/FLX55

Features & Benefits

- ① **Stainless Steel Valve Seat**
Eliminates body damage from rocks and debris. This in-destructible stainless steel seat is molded to the body and virtually eliminates body replacements due to seat damage.
- ② **Ratcheting riser**
Align part circle quickly and easily or adjust watering locations to suit seasonal needs.
- ③ **Industry's Largest Nozzle Selection**
Nozzles from 13,1m - 28,0m (43' to 92") radius plus a wide assortment of back nozzles lets you put the precise amount of water exactly where you need it. All nozzles threaded in from front.
- ④ **True Part and Full-Circle in One – (40° - 330° part circle)**
These sprinklers can be full circle today and part circle tomorrow allowing you to adjust the area of coverage to match your seasonal needs or meet water rationing mandates.



Stainless Steel Valve Seat

① Ratcheting Riser

② Industry's Largest Nozzle Selection

③ True Part and Full-Circle in One

④

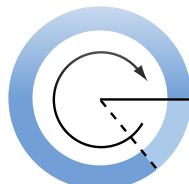

FLEX800™ SERIES GOLF ROTORS FLX35/FLX55



FLX35 Conversion Upgrades

Models	Description
• FLX35-3134	FLX35 w/31–34 Nozzles (#3 Nozzle)
• FLX35-3537	FLX35 w/35–37 Nozzles (#5 Nozzle)



FLX55 Conversion Upgrades (Ribbed Body)

Models	Description
• FLX55-5154	FLX55 w/51–54 Nozzles (#3 Nozzle)
• FLX55-5558	FLX55 w/55–58 Nozzles (#5 Nozzle)
• FLX55-59	FLX55 w/59 Nozzle



FLX55 Conversion Upgrades (Ribless Body)

Models	Description
• FLX55-5154R	FLX55 w/51–54 Nozzles (#3 Nozzle)
• FLX55-5558R	FLX55 w/55–58 Nozzles (#5 Nozzle)
• FLX55-59R	FLX55 w/59 Nozzle



Features

- Dual Trajectory adjustment on main nozzle - 25° or 15°
- Part/Full circle sprinklers
- Radius reduction screw 363-4839 for fine tuning
- Ratcheting riser
- Nozzle base clutching
- Pop-up height to nozzle: 8,25cm (3.25")

Operating Specifications

Inlet:

- FLX35: 25mm (1") ACME
- FLX55: 40mm (1.5") ACME

Radius:

- FLX35: 13,1 – 25,3m (43' – 83')
- FLX55: 16,7 – 28,0m (55' – 92')

Flow Rate:

- FLX35: 31,0 – 179,0 LPM (8.2 – 47.8 GPM)
- FLX55: 53,0 – 232,0 LPM (14.1 – 61.3 GPM)

Precipitation Rates:

- FLX35: Minimum: 10,4 mm/hr (0.41"/hr); Maximum: 11,4 mm/hr (0.45"/hr)
- FLX55: Minimum: 11,7 mm/hr (0.46"/hr); Maximum: 14,7 mm/hr (0.58"/hr)

Pilot Valve:

- Selectable at 3,4; 4,5; 5,5; and 6,9 Bar (50, 65, 80, 100 psi)

Recommended Operating Pressure Range:

- 4,5-6,9 Bar (65-100 psi)
- Maximum: 10,3 Bar (150 psi)
- Minimum: 2,8 Bar (40 psi)

Activation types – Electric Valve-in-Head:

- Standard Solenoid:

- 24 VAC, 50/60 Hz
- Inrush: 0.30 A
- Holding 0.20 A

- Spike Guard Solenoid:

- 24 VAC, 50/60 Hz
- Inrush: 0.12 A
- Holding 0.10 A

- Nickel-Plated Spike Guard Solenoid:

- 24 VAC, 50/60 Hz
- Inrush: 0.12 A
- Holding 0.10 A

- DC Latching Solenoid (DCLS):

- 12 VDC pulse or latching pulse

- Integrated GDC Module w/DCLS:

- 12 VDC pulse or latching pulse

Nozzle Selection

- FLX35 has eight nozzle variations (30, 31, 32, 33, 34, 35, 36 & 37)
- FLX55 has nine nozzle variations (51, 52, 53, 54, 55, 56, 57, 58 & 59)
- Three in-line nozzles, rotating stream pattern
- Two back nozzle positions

Dimensions

- Body diameter:
 - FLX35-6: 16,5cm (6.5")
 - FLX55-6: 19cm (7.5")
- Body height:
 - FLX35: 25cm (10")
 - FLX55: 29cm (11.38")
- Weight:
 - FLX35-6: 1,31kg (2.89 lbs.)
 - FLX55-6: 1,62kg (3.57 lbs.)
- Weight-Integrated GDC
 - FLX35: 1,62kg (3.57 lbs.)
 - FLX55: 1,93kg (4.26 lbs.)

Warranty

- Two years; Five years when installed with Toro Swing Joints

Specifying Information—FLX35 & FLX55

FLXX5-XXX-X					
Body Inlet	Arc	Nozzle	Pressure Regulation*	Activation Type	Trajectory
FLXX	5	XX	X	X	6
3–25mm (1") 5–40mm (1½")	5—Part-circle and Full-circle In One	FLX35—30, 31, 32, 33 , 34, 35, 36, 37 FLX55—51, 52, 53, 54, 55, 56, 57, 58, 59	6— 4,5 bar (65 psi) 8— 5,5 bar (80 psi) 1— 6,9 bar (100 psi)	1—Standard Solenoid 2—Spike Guard™ Solenoid 3—Nickel-plated Spike Guard Solenoid 4—DC Latching Solenoid (DCLS) 5—Integrated GDC Module w/DCLS	6—24-position Trajectory

Example: When specifying an FLX35 Series Sprinkler with #34 nozzle, pressure regulation at 4,5 bar (65 psi) and Spike Guard you would specify: FLX35-346-2

* All sprinklers are equipped with the selectable pilot valve that allows settings at 3,4; 4,5; 5,5; and 6,9 Bar (50, 65, 80 and 100 psi).
Note: Not all models available. Nickel-plated, corrosion-resistant models are available upon request.



FLEX800™ SERIES GOLF ROTORS FLX35/FLX55

FLX35 Performance Data—25° – (Metric)

Front Nozzle Positions	Nozzle Set 30		Nozzle Set 31		Nozzle Set 32		Nozzle Set 33		Nozzle Set 34		Nozzle Set 35		Nozzle Set 36		Nozzle Set 37				
	(White Plug)		(Yellow)		(Blue)		(Brown)		(Orange)		(Green)		(Gray)		(Black)				
	102-2208		102-6906		102-0726		102-6907		102-0728		102-6955		102-6935		102-6936				
Back Nozzle Positions																			
	Red Plug 102-4335																		
	Bar	kPa	kg/cm2	Radius	LPM	Radius	LPM	Radius	LPM	Radius	LPM	Radius	LPM	Radius	LPM	Radius	LPM	Radius	LPM
	3,4	340	3,47	13,1	31,0	16,2	52,2	17,1	69,3	18,6	82,1	—	—	—	—	—	—	—	—
4,5	450	4,59	13,7	37,9	16,2	58,7	18,0	77,6	19,5	92,4	20,7	106,7	22,0	129,1	—	—	—	—	
5,5	550	5,61	14,0	43,5	17,4	65,5	18,9	85,9	20,4	102,6	21,7	117,7	22,9	143,1	23,8	152,5	24,4	166,5	
6,9	690	7,04	14,3	50,7	18,0	72,3	19,8	94,2	21,4	112,8	22,6	129,1	24,1	154,8	24,7	165,8	25,3	179,0	

FLX35 Series Performance Chart—15°

Bar	kPa	kg/cm2	Radius	LPM	Radius	LPM	Radius	LPM	Radius	LPM	Radius	LPM	Radius	LPM	Radius	LPM	Radius	LPM		
3,4	340	3,47	13,1	31,0	15,9	51,5	17,7	68,5	18,6	81,4	—	—	—	—	—	—	—	—		
4,5	450	4,59	13,7	37,9	16,5	57,9	18,3	76,8	19,5	91,6	19,8	103,3	21,0	125,3	—	—	—	—		
5,5	550	5,61	14,0	43,5	17,7	65,1	19,5	85,5	21,0	101,4	21,0	114,3	22,9	139,3	23,2	150,3	23,2	162,4		
6,9	690	7,04	14,3	50,7	18,3	71,9	20,1	93,5	21,7	111,7	22,0	124,5	23,8	149,5	25,0	161,2	25,0	174,5		
Stator			102-6929 Blue						102-1939 Yellow						102-1940 White					
Conversions			FLX35-3134						FLX35-3134						FLX35-3537					

FLX55 Performance Data—25° – (Metric)

Front Nozzle Positions	Nozzle Set 51		Nozzle Set 52		Nozzle Set 53		Nozzle Set 54		Nozzle Set 55		Nozzle Set 56		Nozzle Set 57		Nozzle Set 58		Nozzle Set 59		
	(Yellow)		(Blue)		(Brown)		(Orange)		(Green)		(Gray)		(Black)		(Red)		(Beige)		
	102-6906		102-0726		102-6907		102-0728		102-6955		102-6935		102-6936		102-6909		102-4259		
Back Nozzle Positions																			
	Red Plug 102-4335																		
	Bar	kPa	kg/cm2	Radius	LPM	Radius	LPM	Radius	LPM	Radius	LPM	Radius	LPM	Radius	LPM	Radius	LPM	Radius	LPM
	3,4	340	3,47	16,7	53,4	17,3	70,0	18,9	84,4	20,1	97,6	—	—	—	—	—	—	—	—
4,5	450	4,59	17,4	59,8	18,2	79,1	19,8	95,0	21,0	108,6	22,3	135,8	—	—	—	—	—	—	
5,5	550	5,61	18,0	66,2	18,5	87,4	20,7	105,2	21,9	119,9	23,1	150,3	24,4	163,2	25,2	182,5	25,9	189,3	
6,9	690	7,04	18,6	73	19,2	95,7	21,7	114,7	22,8	130,6	24,4	164,6	25,2	185,5	26,8	194,9	27,4	204,0	

FLX55 Series Performance Chart—15°

Bar	kPa	kg/cm2	Radius	LPM	Radius	LPM	Radius	LPM	Radius	LPM	Radius	LPM	Radius	LPM	Radius	LPM	Radius	LPM		
3,4	340	3,47	16,7	53,0	17,9	62,5	18,9	84,0	19,2	96,9	—	—	—	—	—	—	—	—		
4,5	450	4,59	17,1	59,0	18,8	78,3	19,8	94,6	20,1	107,9	22,8	133,6	—	—	—	—	—	—		
5,5	550	5,61	18,0	65,9	20,1	87,1	21,0	104,8	21,4	119,2	23,1	147,6	23,7	160,5	24,0	177,5	24,0	187,4		
6,9	690	7,04	18,2	72,7	20,7	95,0	21,7	114,3	22,0	129,8	24,4	158,6	24,6	184,3	25,3	192,2	25,3	202,1		
Stator			102-1939 Yellow						102-1940 White						102-1941 White					
Conversions			FLX55-5154						FLX55-5558						FLX55-59					

■ Not recommended at these pressures. Radius shown in meters.
 Toro recommends the use of a 30mm swing joint at flows over 95-LPM. Sprinkler radius of throw per ASAE standard S398.1.
 All sprinklers are equipped with the selectable pilot valve that allows settings at 3,4; 4,5; 5,5; and 6,9 Bar.

FLX35 Nozzle Apex—(Metric)

Pressure	Nozzle	Apex at 15°	Apex at 25°
4,5 bar	31	1,8m @ 15,5m	4m @ 16,4m
	32	1,8m @ 15,5m	3,4m @ 19,5m
	33	2,1m @ 18m	4m @ 20,7m
	34	2,4m @ 19m	4,6m @ 22,6m
	35	2,7m @ 20m	4,6m @ 23m
5,5 bar	36	2,4m @ 22,9m	5,5m @ 25,3m
	37	2,7m @ 22,5m	5,8m @ 25m

























FLX55 Nozzle Apex—(Metric)

Pressure	Nozzle	Apex at 15°	Apex at 25°
4,5 bar	51	1,8m @ 15,5m	4m @ 16,4m
	52	1,8m @ 15,5m	3,4m @ 19,5m
	53	2,1m @ 18m	4m @ 20,7m
	54	2,4m @ 19m	4,6m @ 22,6m
	55	2,7m @ 20m	4,6m @ 23m
5,5 bar	56	2,4m @ 22,9m	5,5m @ 25,3m
	57	2,7m @ 22,5m	5,8m @ 25m
	58	3m @ 25m	5,5m @ 26,5m
	59	3,4m @ 24,6m	6,4m @ 27,7m



FLEX800™ SERIES GOLF ROTORS FLX35/FLX55



























FLX35 Performance Data—25° – (U.S.)

Front Nozzle Positions	Nozzle Set 30		Nozzle Set 31		Nozzle Set 32		Nozzle Set 33		Nozzle Set 34		Nozzle Set 35		Nozzle Set 36		Nozzle Set 37	
																
	(White Plug)		(Yellow)		(Blue)		(Brown)		(Orange)		(Green)		(Gray)		(Black)	
	102-2208		102-6906		102-0726		102-6907		102-0728		102-6955		102-6935		102-6936	
																
	102-5670	102-6942	102-5670	102-5671	102-5670	102-6884	102-5670	102-6884	102-5670	102-6884	102-5670	102-6885	102-6531	102-6885	102-6531	102-6885
Back Nozzle Positions	 Red Plug 102-4335															
PSI	Radius	GPM	Radius	GPM	Radius	GPM	Radius	GPM	Radius	GPM	Radius	GPM	Radius	GPM	Radius	GPM
50	43	8.2	53	13.8	56	18.3	61	21.7	65	25.3	—	—	—	—	—	—
65	45	10.0	53	15.5	59	20.5	64	24.4	68	28.2	72	34.1	—	—	—	—
80	46	11.5	57	17.3	62	22.7	67	27.1	71	31.1	75	37.8	78	40.3	80	44.0
100	47	13.4	59	19.1	65	24.9	70	29.8	74	34.1	79	40.9	81	43.8	83	47.3

FLX35 Series Performance Chart—15°

PSI	Radius	GPM	Radius	GPM	Radius	GPM	Radius	GPM	Radius	GPM	Radius	GPM	Radius	GPM	Radius	GPM		
50	43	8.2	52	13.6	58	18.1	61	21.5	62	25.6	—	—	—	—	—	—		
65	45	10.0	54	15.3	60	20.3	64	24.2	65	27.3	69	33.1	—	—	—	—		
80	46	11.5	58	17.2	64	22.6	69	26.8	69	30.2	75	36.8	76	39.7	76	42.9		
100	47	13.4	60	19.0	66	24.7	71	29.5	72	32.9	78	39.5	82	42.6	82	46.1		
Stator	102-6929 Blue						102-1939 Yellow						102-1940 White					
Conversions	FLX35-3134						FLX35-3134						FLX35-3537					

FLX55 Performance Data—25° – (U.S.)

Front Nozzle Positions	Nozzle Set 51		Nozzle Set 52		Nozzle Set 53		Nozzle Set 54		Nozzle Set 55		Nozzle Set 56		Nozzle Set 57		Nozzle Set 58		Nozzle Set 59	
																		
	(Yellow)		(Blue)		(Brown)		(Orange)		(Green)		(Gray)		(Black)		(Red)		(Beige)	
	102-6906		102-0726		102-6907		102-0728		102-6955		102-6935		102-6936		102-6909		102-4259	
																		
	102-5670	102-5671	102-5670	102-6884	102-5670	102-6884	102-5670	102-6884	102-5670	102-6885	102-6531	102-6885	102-6531	102-6885	102-6531	102-6885		
Back Nozzle Positions	 Red Plug 102-4335																	
PSI	Radius	GPM	Radius	GPM	Radius	GPM	Radius	GPM	Radius	GPM	Radius	GPM	Radius	GPM	Radius	GPM		
50	55	14.1	57	18.5	62	22.3	66	25.8	—	—	—	—	—	—	—	—		
65	57	15.8	60	20.9	65	25.1	69	28.7	73	35.9	—	—	—	—	—	—		
80	59	17.5	61	23.1	68	27.8	72	31.7	76	39.7	80	43.1	83	48.2	85	50.0		
100	61	19.3	63	25.3	71	30.3	75	34.5	80	43.5	83	49.0	88	51.5	90	53.9		

FLX55 Series Performance Chart—15°

PSI	Radius	GPM	Radius	GPM	Radius	GPM	Radius	GPM	Radius	GPM	Radius	GPM	Radius	GPM	Radius	GPM
50	55	14.0	59	16.5	62	22.2	63	25.6	—	—	—	—	—	—	—	—
65	56	15.6	62	20.7	65	25.0	66	28.5	75	35.3	—	—	—	—	—	—
80	59	17.4	66	23.0	69	27.7	70	31.5	78	39.0	78	42.4	79	46.9	79	49.5
100	60	19.2	68	25.1	71	30.2	72	34.3	80	41.9	81	47.2	83	52.1	83	53.4
Stator	102-1939 Yellow						102-1940 White						102-1941 White			
Conversions	FLX55-5154						FLX55-5558						FLX55-59			

Not recommended at these pressures.
Toro recommends the use of a 1 1/4" swing joint at flows over 25-GPM. Sprinkler radius of throw per ASAE standard S398.1.
All sprinklers are equipped with the selectable pilot valve that allows settings at 50, 65, 80 and 100 psi.

FLX35 Nozzle Apex—(U.S.)

Pressure	Nozzle	Apex at 15°	Apex at 25°
65 PSI	31	6' @ 51'	13' @ 54'
	32	6' @ 51'	11' @ 64'
	33	7' @ 59'	13' @ 68'
	34	8' @ 63'	15' @ 74'
	35	9' @ 66'	15' @ 76'
80 PSI	36	8' @ 75'	18' @ 83'
	37	9' @ 74'	19' @ 82'

FLX55 Nozzle Apex—(U.S.)

Pressure	Nozzle	Apex at 15°	Apex at 25°
65 PSI	51	6' @ 51'	13' @ 54'
	52	6' @ 51'	11' @ 64'
	53	7' @ 59'	13' @ 68'
	54	8' @ 63'	15' @ 74'
	55	9' @ 66'	15' @ 76'
80 PSI	56	8' @ 75'	18' @ 83'
	57	9' @ 74'	19' @ 82'
	58	10' @ 82'	18' @ 87'
	59	11' @ 81'	21' @ 91'



FLEX800™ SERIES GOLF ROTORS FLX34/FLX54



Learn more at
Toro.com

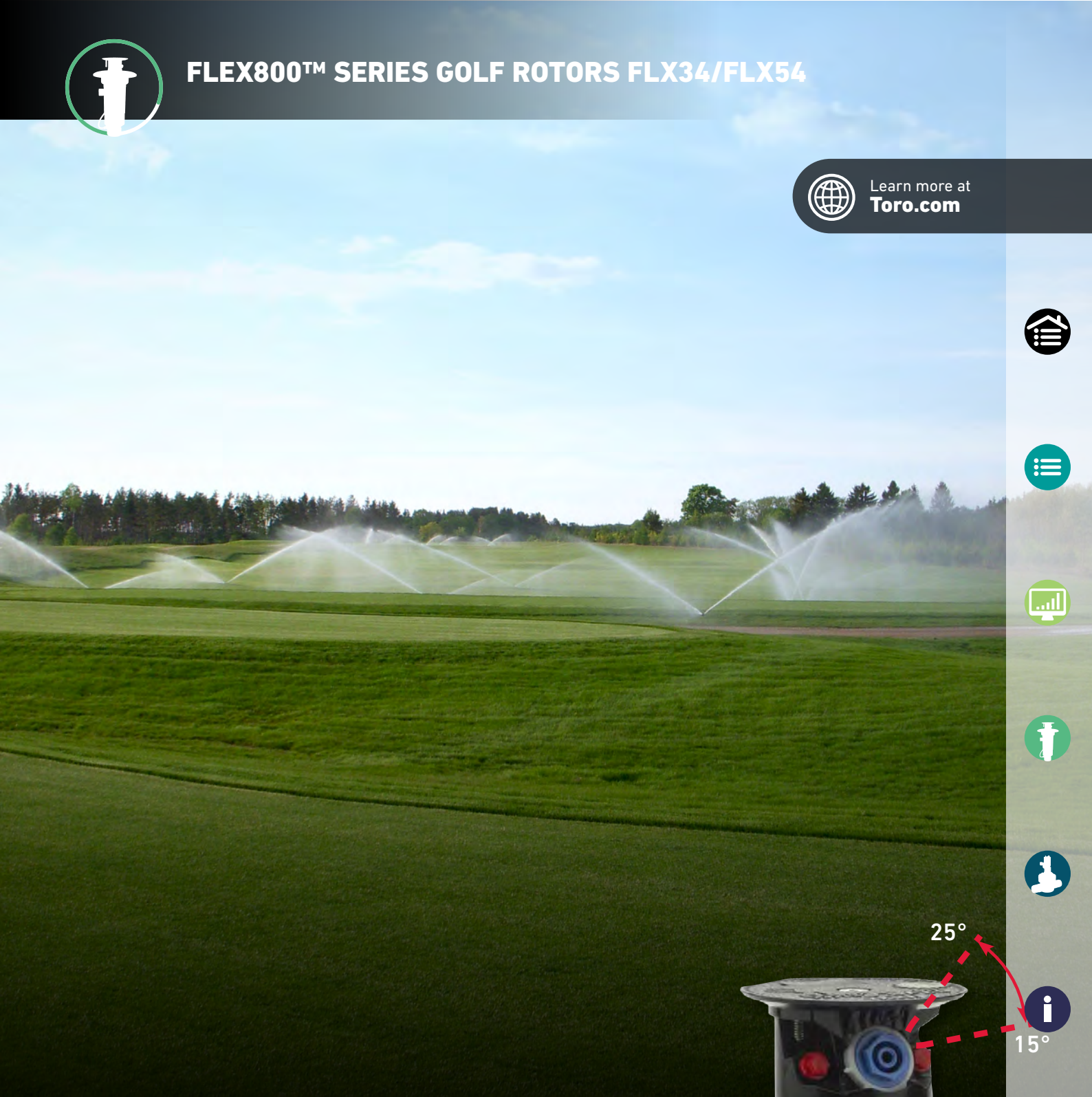

25°

15°

Dual Trajectory

Features & Benefits



Specifications



Performance Data



The NEW FLEX34/54 are the full circle irrigation sprinklers in the FLEX800™ Series. They come with dual trajectory main nozzle that provides exceptional nozzle performance at the 25° standard angle position and great performance in windy applications at the 15° low angle position. And the consistency of the constant velocity full circle drive ensures even water application across the coverage area every time you water.

TORO.





FLEX800™ SERIES GOLF ROTORS FLX34/FLX54

Features & Benefits

- 1 **Industry's Largest Nozzle Selection**
Nozzles from 15,8 – 30,5m (52' to 100') plus a wide assortment of back nozzles lets you put the precise amount of water exactly where you need it. All nozzles threaded in from front.
- 2 **Stainless Steel Valve Seat**
Eliminates body damage from rocks and debris. This in-destructible stainless steel seat is molded to the body and virtually eliminates body replacements due to seat damage.

- 3 **Optional Radius Reduction Screw**
Allows for fine tuning the radius to exactly the distance you need. In combination with main nozzle sizing and trajectory adjustment the radius reduction screw can effectively reduce the sprinkler throw down to 9,1m (30').
- 4 **Constant Velocity Full Circle Drive**
Ensures consistent rotation speeds when matched with station run times for even water application across the coverage area every time you water.



Industry's Largest Nozzle Selection



Stainless Steel Valve Seat



Radius Reduction Screw



Constant Velocity Full-Circle Drive

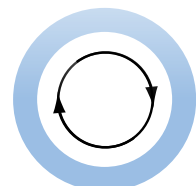

FLEX800™ SERIES GOLF ROTORS FLX34/FLX54



FLX34 Conversion Upgrades

Models	Description
• FLX34-3134	FLX34 w/31–34 Nozzles (#3 Nozzle)
• FLX34-3537	FLX34 w/35–37 Nozzles (#5 Nozzle)



FLX54 Conversion Upgrades

Models	Description
• FLX54-5154	FLX54 w/51–54 Nozzles (#3 Nozzle Installed)
• FLX54-5558	FLX54 w/55–58 Nozzles (#5 Nozzle)
• FLX54-59	FLX54 w/59 Nozzle



Features

- Dual Trajectory adjustment on main nozzle - 25° or 15°
- Full circle sprinklers
- Pop-up height to nozzle: 8,3cm (3.25")

Operating Specifications

Inlet

- FLX34: 25mm (1") ACME
- FLX54: 40mm (1.5") ACME

Radius

- FLX34: 15,8 – 27,7m (52' – 91')
- FLX54: 15,8 – 30,2m (52' – 99')

Flow Rate:

- FLX34: 48,8 - 177,5 LPM (13.0 – 46.9 GPM)
- FLX54: 50 - 233,9 LPM (13.2 – 61.8 GPM)

Precipitation Rates:

- FLX34: Minimum - 8,4mm/hr (0.33"/hr); Maximum - 14mm/hr (0.55"/hr)
- FLX54: Minimum - 8,4mm/hr (0.33"/hr); Maximum 15,5mm/hr (0.61"/hr)

Pilot Valve:

- Selectable at 3,4; 4,5; 5,5; and 6,9 Bar (50, 65, 80,100 psi)

Recommended Operating Pressure Range:

- 4,5-6,9 Bar (65-100 psi)
- Maximum: 10,3 Bar (150 psi)
- Minimum: 2,8 Bar (40 psi)

Activation types – Electric Valve-in-Head:

- Standard Solenoid:
 - 24 VAC, 50/60 Hz
 - Inrush: 0.30 A
 - Holding 0.20 A
- Spike Guard Solenoid:
 - 24 VAC, 50/60 Hz
 - Inrush: 0.12 A
 - Holding 0.10 A
- Nickel-Plated Spike Guard Solenoid:
 - 24 VAC, 50/60 Hz
 - Inrush: 0.12 A
 - Holding 0.10 A
- DC Latching Solenoid (DCLS):
 - 12 VDC pulse or latching pulse
- Integrated GDC Module w/DCLS:
 - 12 VDC pulse or latching pulse

Nozzle Selection

- FLX34 has seven nozzle variation (31, 32, 33, 34, 35, 36 and 37)
- FLX54 has nine nozzle variations (51, 52, 53, 54, 55, 56, 57, 58 and 59)
- Three opposing nozzles, rotating stream pattern
- Two additional front nozzle positions

Dimensions

- Body diameter:
 - FLX34: 16,5cm (6.5")
 - FLX54: 19,1cm (7.5")
- Body height:
 - FLX34: 25,4cm (10")
 - FLX54: 28,9cm (11.375")
- Weight:
 - FLX34: 1,35kg (2.98 lbs.)
 - FLX54: 1,68kg (3.70 lbs.)

Warranty

- Two years; Five years when installed with Toro Swing Joints

Specifying Information—FLX34 & FLX54

FLXX4-XXX-X					
Body Inlet	Arc	Nozzle	Pressure Regulation*	Activation Type	Trajectory
FLXX	4	XX	X	X	6
3— 25mm (1") 5— 40mm (1.5")	4—Full Circle	FLX34—31, 32, 33, 34, 35, 36, 37 FLX54—51, 52, 53, 54, 55, 56, 57, 58, 59	6— 4,5 bar (65 psi) 8— 5,5 bar (80 psi) 1— 6,9 bar (100 psi)	1—Standard Solenoid 2—Spike Guard™ Solenoid 3—Nickel-plated Spike Guard Solenoid 4—DC Latching Solenoid (DCLS) 5—Integrated GDC Module w/DCLS	6—24-position TruJectory
Example: When specifying a FLX34 Series Sprinkler with #34 nozzle, pressure regulation at 4,5 bar (65 psi), and Spike Guard™ Solenoid you would specify: FLX34-346-2					

* Electric models only. All sprinklers are equipped with the selectable pilot valve that allows settings at 3,4; 4,5; 5,5; and 6,9 Bar (50, 65, 80 and 100 psi).
Note: Not all models available. Nickel-plated, corrosion-resistant models are available upon request.



FLEX800™ SERIES GOLF ROTORS FLX34/FLX54

FLX34 Series Performance Chart—25° (Metric)

Front Nozzle Positions			Nozzle Set 31		Nozzle Set 32		Nozzle Set 33		Nozzle Set 34		Nozzle Set 35		Nozzle Set 36		Nozzle Set 37	
			(Yellow) 102-0725	(Blue) 102-7001	(Brown) 102-0727	(Orange) 102-7002	(Green) 102-6908	(Gray) 102-0730	(Black) 102-4261	Red Plug 102-4335						
Back Nozzle Positions			Yellow 102-6937	Blue 102-2925	Yellow 102-6937	Orange 102-2926	Yellow 102-6937	Red 102-2928	Yellow 102-6937	Beige 102-2929	Yellow 102-6937	Beige 102-2929	Yellow 102-6937	Red 102-2928	Yellow 102-6937	Gray 102-6945
Bar	kPa	kg/cm ²	Radius	LPM	Radius	LPM	Radius	LPM	Radius	LPM	Radius	LPM	Radius	LPM	Radius	LPM
3,4	340	3,47	17,4	49,2	17,7	58,7	19,5	82,9	20,7	92,4	—	—	—	—	—	—
4,5	450	4,59	17,7	55,3	18,3	68,1	20,7	92,4	22,0	106,4	23,2	121,9	—	—	—	—
5,5	550	5,61	18,3	61,3	19,2	77,6	22,0	101,8	23,2	117,7	24,4	134,7	25,3	144,6	25,9	157,1
6,9	690	7,04	18,9	67,8	20,1	88,6	22,9	112,8	24,1	132,1	25,6	148,8	26,8	164,3	27,8	177,5

FLX34 Series Performance Chart—15°

Bar	kPa	kg/cm ²	Radius	LPM	Radius	LPM	Radius	LPM	Radius	LPM	Radius	LPM	Radius	LPM	Radius	LPM
3,4	340	3,47	15,9	48,8	16,2	59,0	18,3	82,1	18,9	96,5	—	—	—	—	—	—
4,5	450	4,59	16,2	54,5	16,5	64,7	18,6	91,6	19,5	106,0	20,4	121,5	—	—	—	—
5,5	550	5,61	17,1	60,6	17,4	71,9	19,8	100,7	21,0	117,3	22,3	134,4	23,2	143,8	23,5	156,3
6,9	690	7,04	17,4	66,2	18,0	77,6	20,4	111,7	21,7	128,3	22,9	145,3	24,4	163,1	24,7	177,1
Stator							102-6929 Blue					102-1940 White				
Conversions							FLX34-3134					FLX34-3537				

FLX54 Series Performance Chart—25° (Metric)

Front Nozzle Positions			Nozzle Set 51		Nozzle Set 52		Nozzle Set 53		Nozzle Set 54		Nozzle Set 55		Nozzle Set 56		Nozzle Set 57		Nozzle Set 58		Nozzle Set 59	
			(Yellow) 102-0725	(Blue) 102-7001	(Brown) 102-0727	(Orange) 102-7002	(Green) 102-6908	(Gray) 102-0730	(Black) 102-4261	(Red) 102-4260	(Beige) 102-4259	Red Plug 102-4335								
Back Nozzle Positions			Yellow 102-6937	Blue 102-2925	Yellow 102-6937	Orange 102-2926	Yellow 102-6937	Red 102-2928	Yellow 102-6937	Beige 102-2929	Yellow 102-6937	Beige 102-2929	Yellow 102-6937	Red 102-6944	Yellow 102-6937	Gray 102-6945	Yellow 102-6937	Gray 102-6945	Yellow 102-6937	Gray 102-6945
Bar	kPa	kg/cm ²	Radius	LPM	Radius	LPM	Radius	LPM	Radius	LPM	Radius	LPM	Radius	LPM	Radius	LPM	Radius	LPM	Radius	LPM
3,4	340	3,47	17,7	50,0	18,0	59,4	19,5	83,3	21,4	99,2	—	—	—	—	—	—	—	—	—	—
4,5	450	4,59	18,3	56,0	18,6	66,2	20,7	93,9	22,6	110,9	24,1	129,4	—	—	—	—	—	—	—	—
5,5	550	5,61	18,6	62,1	19,5	75,7	22,0	104,5	23,8	123,4	25,3	143,8	25,9	154,0	26,5	169,9	27,8	190,0	29,3	210,4
6,9	690	7,04	19,2	68,5	20,4	89,3	22,9	115,1	24,7	138,9	26,5	160,9	27,5	173,4	28,4	190,0	29,0	209,7	30,2	233,9

FLX54 Series Performance Chart—15°

Bar	kPa	kg/cm ²	Radius	LPM	Radius	LPM	Radius	LPM	Radius	LPM	Radius	LPM	Radius	LPM	Radius	LPM	Radius	LPM	Radius	LPM
3,4	340	3,47	15,9	50,0	16,2	59,8	18,6	83,3	19,8	98,4	—	—	—	—	—	—	—	—	—	—
4,5	450	4,59	16,2	56,0	16,5	65,9	19,2	93,9	20,4	110,5	21,0	129,1	—	—	—	—	—	—	—	—
5,5	550	5,61	17,1	62,1	17,7	73,4	20,7	104,5	22,0	123,0	22,9	143,1	24,1	152,9	24,7	168,8	25,9	188,9	26,5	209,3
6,9	690	7,04	17,7	68,5	18,3	79,9	21,7	115,1	22,9	137,8	24,1	160,1	25,6	172,2	26,5	188,9	27,1	208,6	28,7	232,8
Stator							102-6929 Blue					102-1940 White					102-1941 White			
Conversions							FLX54-5154					FLX54-5558					FLX54-59			

*Not recommended at these pressures. Radius shown in meter.
Toro recommends the use of a 30mm swing joint at flows over 95-LPM. Sprinkler radius of throw per ASAE standard S398.1.
Actual site conditions must be considered when selecting the appropriate nozzle.
All sprinklers are equipped with the selectable pilot valve that allows settings at 3,4; 4,5; 5,5 and 6,9 Bar.*

FLX34 Nozzle Apex—(Metric)

Pressure	Nozzle	Apex at 15°	Apex at 25°
4,5 bar	31	1,8 @ 15,6	4,0 @ 16,5
	32	1,8 @ 15,6	3,4 @ 19,5
	33	2,1 @ 18,0	4,0 @ 20,7
	34	2,4 @ 19,2	4,6 @ 22,6
	35	2,7 @ 20,1	4,6 @ 23,2
5,5 bar	36	2,4 @ 22,9	5,5 @ 25,3
	37	2,7 @ 22,6	5,8 @ 25,0

FLX54 Nozzle Apex—(Metric)

Pressure	Nozzle	Apex at 15°	Apex at 25°
4,5 Bar	51	1,8 @ 15,6	4,0 @ 16,5
	52	1,8 @ 15,6	3,4 @ 19,5
	53	2,1 @ 18,0	4,0 @ 20,7
	54	2,4 @ 19,2	4,6 @ 22,6
	55	2,7 @ 20,1	4,6 @ 23,2
5,5 Bar	56	2,4 @ 22,9	5,5 @ 25,3
	57	2,7 @ 22,6	5,8 @ 25,0
	58	3,0 @ 25,0	5,5 @ 26,5
	59	3,4 @ 24,7	6,4 @ 27,1



FLEX800™ SERIES GOLF ROTORS FLX34/FLX54

FLX34 Series Performance Chart—25° (U.S.)

Front Nozzle Positions	Nozzle Set 31 (Yellow) 102-0725		Nozzle Set 32 (Blue) 102-7001		Nozzle Set 33 (Brown) 102-0727		Nozzle Set 34 (Orange) 102-7002		Nozzle Set 35 (Green) 102-6908		Nozzle Set 36 (Gray) 102-0730		Nozzle Set 37 (Black) 102-4261	
	 Red Plug 102-4335													
Back Nozzle Positions	 Yellow 102-6937	 Blue 102-2925	 Yellow 102-6937	 Orange 102-2926	 Yellow 102-6937	 Red 102-2928	 Yellow 102-6937	 Beige 102-2929	 Yellow 102-6937	 Beige 102-2929	 Yellow 102-6937	 Red 102-2928	 Yellow 102-6937	 Gray 102-6945
PSI	Radius	GPM	Radius	GPM	Radius	GPM	Radius	GPM	Radius	GPM	Radius	GPM	Radius	GPM
50	57	13.0	58	15.5	64	21.9	68	24.4	—	—	—	—	—	—
65	58	14.6	60	18.0	68	24.4	72	28.1	76	32.2	—	—	—	—
80	60	16.2	63	20.5	72	26.9	76	31.1	80	35.6	83	38.2	85	41.5
100	62	17.9	66	23.4	75	29.8	79	34.9	84	39.3	88	43.4	91	46.9

FLX34 Series Performance Chart—15°

psi	Radius	GPM	Radius	GPM	Radius	GPM	Radius	GPM	Radius	GPM	Radius	GPM	Radius	GPM
50	52	12.9	53	15.6	60	21.7	62	25.5	—	—	—	—	—	—
65	53	14.4	54	17.1	61	24.2	64	28.0	67	32.1	—	—	—	—
80	56	16.0	57	19.0	65	26.6	69	31.0	73	35.5	76	38.0	77	41.3
100	57	17.5	59	20.5	67	29.5	71	33.9	75	38.4	80	43.1	81	46.8
Stator	102-6929 Blue						102-1940 White							
Conversions	FLX34-3134						FLX34-3537							

FLX54 Series Performance Chart—25° (U.S.)

Front Nozzle Positions	Nozzle Set 51 (Yellow) 102-0725		Nozzle Set 52 (Blue) 102-7001		Nozzle Set 53 (Brown) 102-0727		Nozzle Set 54 (Orange) 102-7002		Nozzle Set 55 (Green) 102-6908		Nozzle Set 56 (Gray) 102-0730		Nozzle Set 57 (Black) 102-4261		Nozzle Set 58 (Red) 102-4260		Nozzle Set 59 (Beige) 102-4259	
	 Red Plug 102-4335																	
Back Nozzle Positions	 Yellow 102-6937	 Blue 102-2925	 Yellow 102-6937	 Orange 102-2926	 Yellow 102-6937	 Red 102-2928	 Yellow 102-6937	 Beige 102-2929	 Yellow 102-6937	 Beige 102-2929	 Yellow 102-6937	 Red 102-2928	 Yellow 102-6937	 Gray 102-6945	 Yellow 102-6937	 Gray 102-6945	 Yellow 102-6937	 Gray 102-6945
PSI	Radius	GPM	Radius	GPM	Radius	GPM	Radius	GPM	Radius	GPM	Radius	GPM	Radius	GPM	Radius	GPM	Radius	GPM
50	58	13.2	59	15.7	64	22.0	70	26.2	—	—	—	—	—	—	—	—	—	—
65	60	14.8	61	17.5	68	24.8	74	29.3	79	34.2	—	—	—	—	—	—	—	—
80	61	16.4	64	20.0	72	27.6	78	32.6	83	38.0	85	40.7	87	44.9	91	50.2	96	55.6
100	63	18.1	67	23.6	75	30.4	81	36.7	87	42.5	90	45.8	93	50.2	95	55.4	99	61.8

FLX54 Series Performance Chart—15°

psi	Radius	GPM	Radius	GPM	Radius	GPM	Radius	GPM	Radius	GPM	Radius	GPM	Radius	GPM	Radius	GPM	Radius	GPM
50	52	13.2	53	15.8	61	22.0	65	26.0	—	—	—	—	—	—	—	—	—	—
65	53	14.8	54	17.4	63	24.8	67	29.2	69	34.1	—	—	—	—	—	—	—	—
80	56	16.4	58	19.4	68	27.6	72	32.5	75	37.8	79	40.4	81	44.6	85	49.9	87	55.3
100	58	18.1	60	21.1	71	30.4	75	36.4	79	42.3	84	45.5	87	49.9	89	55.1	94	61.5
Stator	102-6929 Blue						102-1940 White						102-1941 White					
Conversions	FLX54-5154						FLX54-5558						FLX54-59					

■ Not recommended at these pressures. Radius shown in feet.
Toro recommends the use of a 1 1/4" swing joint at flows over 25-GPM. Sprinkler radius of throw per ASAE standard S398.1.
Actual site conditions must be considered when selecting the appropriate nozzle.
All sprinklers are equipped with the selectable pilot valve that allows settings at 50, 65, 80 and 100 psi.

FLX34 Nozzle Apex—(U.S.)

Pressure	Nozzle	Apex at 15°	Apex at 25°
65 PSI	31	6' @ 51'	13' @ 54'
	32	6' @ 51'	11' @ 64'
	33	7' @ 59'	13' @ 68'
	34	8' @ 63'	15' @ 74'
	35	9' @ 66'	15' @ 76'
80 PSI	36	8' @ 75'	18' @ 83'
	37	9' @ 74'	19' @ 82'

FLX54 Nozzle Apex—(U.S.)

Pressure	Nozzle	Apex at 15°	Apex at 25°
65 PSI	51	6' @ 51'	13' @ 54'
	52	6' @ 51'	11' @ 64'
	53	7' @ 59'	13' @ 68'
	54	8' @ 63'	15' @ 74'
	55	9' @ 66'	15' @ 76'
80 PSI	56	8' @ 75'	18' @ 83'
	57	9' @ 74'	19' @ 82'
	58	10' @ 82'	18' @ 87'
	59	11' @ 81'	21' @ 91'



FLEX800™ B SERIES GOLF ROTORS



Learn more at
Toro.com



The FLEX800™ B Series golf sprinkler family brings you all the great features and performance of the FLEX800 35-6, 34 and 35 Series sprinklers in a more economical body package specifically designed for block systems. With its rugged golf body design, small exposed surface diameter, flanged body for stability and check valve these sprinklers are perfect for every golf application.

Features & Benefits



Specifications



Performance Data



*Main Nozzle Adapter
A wide assortment of
intermediate and inner nozzles
for use in the main nozzle adapter
and back nozzle position provide
unmatched nozzle flexibility.*





FLEX800™ B SERIES GOLF ROTORS

Features & Benefits

- ① **Industry's Largest Nozzle Selection**
Nozzles from 7,6 – 29,0m (25' to 95') radius, plus a wide assortment of intermediate and inner nozzles, provide unmatched flexibility allowing you to put the precise amount of water exactly where you need it. All nozzles threaded in from front.
- ② **True Part Full-Circle in One – (40° - 330° part circle)**
These sprinklers can be full circle or part circle allowing you to adjust the area of coverage to match your seasonal needs or meet water rationing mandates.
- ③ **Flanged Cap Installs Below Grade**
Stabilizes the body position and maintains optimum nozzle performance.
- ④ **Small Exposed Diameter**
Minimizes the appearance of the sprinkler to maximize the beauty of the course. Perfect for high traffic areas like tees, greens and surrounds.



Industry's Largest Nozzle Selection



True Part and Full-Circle in One



Below Grade-Installed Flanged Cap



Small Exposed Diameter



FLEX800™ B SERIES GOLF ROTORS



Nozzle Trajectory Provides Unmatched Performance
FLX35-6B with TruJectory™ adjustment from 7°-30° in 1° increments and FLX35/FLX34 models with dual trajectory settings of 25° or 15° provide improved wind performance, obstacle avoidance and radius adjustment.



Features

- Ratcheting riser
- Nozzle base clutching – Part circle models

Operating Specifications

- Inlet:
 - 25mm (1") NPT, BSP or ACME
- Radius:
 - FLX35-6B: 9m – 29m (29' – 95')
 - FLX35B: 9m – 27m (29' – 90')
 - FLX34B: 17m – 29m (57' – 95')
- Flow Rate:
 - FLX35-6B: 26,8 – 198,7 LPM (7.1 – 52.5 gpm)
 - FLX35B: 31,0 – 213,1 LPM (8.2 – 56.3 gpm)
 - FLX34B: 49,2 – 209,7 LPM (13.0 – 55.4 gpm)
- Precipitation Rates:
 - FLX35-6B: 8,6 – 14,2 mm/hr (0.34 in/hr – 0.56 in/hr)
 - FLX35B: 9,3 – 17,0 mm/hr (0.37 in/hr – 0.67 in/hr)
 - FLX34B: 8,3 – 14,9 mm/hr (0.33 in/hr – 0.59 in/hr)
- Recommended Operating Pressure
 - 4,4 – 6,9 Bar (65-100 psi)
- Trajectory:
 - FLX35-6B – 7°-30° in 1° increments; 24 positions
 - FLX35B – 15° or 25° – 2 positions
 - FLX34B – 15° or 25° – 2 positions
- Check-O-Matic feature prevents low head drainage up to 10' of elevation change

Nozzle Selection

- Nozzle variations
 - FLX35-6B – Nine variations (30, 31, 32, 33, 34, 35, 36, 37 & 38)
 - FLX35B – Nine variations (30, 31, 32, 33, 34, 35, 36, 37 & 38)
 - FLX34B – Eight variations (31, 32, 33, 34, 35, 36, 37 & 38)
- Back nozzle capability on part circle models standard
 - FLX35-6B – one position available
 - FLX35B – two positions available
- FLX34B – two additional front nozzle positions
- Main-less capability for short radius applications
- Stator variations:
 - FLX35-6B, FLX35: 3
 - FLX34: 2
- Radius reduction screw for fine tuning the radius (363-4839). Standard on FLX35B; optional on FLX34B and not available on FLX35-6B models

Dimensions

- Body diameter: 15,2cm (6")
- Body height: 21,6cm (8.5")
- Weight:
 - FLX35-6B: 0,9kg (1.99 lbs)
 - FLX35B: 0,9kg (2 lbs)
 - FLX34B: 0,89kg (1.97 lbs)
- Pop-up height to nozzle: 8,25cm (3.25")

Warranty

- Two years; Five years when installed with Toro Swing Joints

Specifying Information – B Series

FLX3XB-X2-XXXX					
Series	Arc	System	Thread Type	Valve Type	Nozzle
FLX3	X	B	X	2	XXXX
FLX3—FLEX800 B Series	4—Full-Circle (DT only) 5—Part-/Full-Circle 5-6--Part-/Full-Circle with TruJectory	B—Block	0—NPT 4—ACME 5—BSP	Check-O-Matic	3134— Includes nozzles #31, 32, 33 & 34 3538— Includes nozzles #35, 36, 37 & 38

Example: When specifying a FLEX800 B Series Sprinkler with full circle - NPT threads, #34 nozzle, you would specify: FLX34B-02-3134



FLEX800™ B SERIES GOLF ROTORS

FLX35-6B Series Performance Chart—25° (Metric)

Base Pressure			Nozzle Set 30		Nozzle Set 31		Nozzle Set 32		Nozzle Set 33		Nozzle Set 34		Nozzle Set 35		Nozzle Set 36		Nozzle Set 37		Nozzle Set 38	
			(White) 102-2208	(Yellow) 102-4587	(Blue) 102-4588	(Brown) 102-4589	(Orange) 102-0728	(Green) 102-0729	(Gray) 102-0730	(Black) 102-4261	(Red) 102-6909	Blue 102-2925	Gray 102-2910	Blue 102-2925	Gray 102-2910	Blue 102-2925	Gray 102-2910	Blue 102-2925	Gray 102-2910	Blue 102-2925
Back Nozzle 102-4335 Red Plug																				
Bar	kPa	kg/cm ²	Radius	LPM	Radius	LPM	Radius	LPM	Radius	LPM	Radius	LPM	Radius	LPM	Radius	LPM	Radius	LPM	Radius	LPM
3,5	345	3,52	13	26,9	16	53,0	18	68,1	—	—	—	—	—	—	—	—	—	—	—	—
4,1	414	4,22	13	30,0	16	57,5	18	73,9	20	82,9	—	—	—	—	—	—	—	—	—	—
4,8	483	4,92	14	33,1	17	62,1	19	79,6	21	89,3	23	123,8	23	133,2	—	—	—	—	—	—
5,5	552	5,63	14	36,3	17	65,9	20	85,5	21	95,8	23	132,9	24	142,7	26	149,9	26	164,3	27	179,8
6,2	621	6,33	14	39,4	18	70,0	21	90,5	22	101,2	24	140,0	25	151,0	26	158,6	27	173,7	28	189,3
6,9	689	7,03	15	42,4	18	73,4	21	95,4	23	106,7	24	147,2	26	158,2	27	166,9	27	183,2	29	198,7
Stator			102-1939 Yellow									102-1940 White								
Conversions			INF35-6-3134 (Requires screen replacement)									INF35-6-3537 (Requires screen replacement)								

FLX35B Series Performance Chart—25° (Metric)

Front Nozzle Positions			Nozzle Set 30		Nozzle Set 31		Nozzle Set 32		Nozzle Set 33		Nozzle Set 34		Nozzle Set 35		Nozzle Set 36		Nozzle Set 37		Nozzle Set 38							
			(White Plug) 102-2208	(Yellow) 102-6906	(Blue) 102-0726	(Brown) 102-6907	(Orange) 102-0728	(Green) 102-6955	(Gray) 102-6935	(Black) 102-6936	(Red) 102-6909	Yellow 102-5670	Beige 102-6942	Yellow 102-5670	Brown 102-5671	Yellow 102-5670	Yellow 102-6884	Yellow 102-5670	Yellow 102-6884	Yellow 102-5670	Yellow 102-6884	Yellow 102-5670	Green 102-6885	Green 102-6531	Green 102-6885	Green 102-6531
Back Nozzles 102-4335 Red Plug																										
Bar	kPa	kg/cm ²	rad/m	lpm	rad/m	lpm	rad/m	lpm	rad/m	lpm	rad/m	lpm	rad/m	lpm	rad/m	lpm	rad/m	lpm	rad/m	lpm						
3,5	345	3,52	13	31,0	17	51,5	17	69,3	—	—	—	—	—	—	—	—	—	—	—	—						
4,1	414	4,22	13	35,2	17	56,8	18	76,1	19	91,6	—	—	—	—	—	—	—	—	—	—						
4,8	483	4,92	14	39,3	18	61,3	18	82,5	20	99,5	21	113,6	22	140,0	—	—	—	—	—	—						
5,5	552	5,63	14	43,5	18	65,5	19	88,2	20	106,0	22	121,5	23	149,9	24	162,4	24	184,0	26	191,5						
6,2	621	6,33	14	47,1	18	69,6	19	93,5	21	112,8	22	129,4	23	159,0	24	171,8	25	194,9	27	202,9						
6,9	689	7,03	14	50,7	19	73,1	20	98,4	21	118,8	23	135,9	24	167,3	25	184,7	25	205,1	27	213,1						
Stator			102-1939 Yellow									102-1940 White														
Conversions			FLX35-3134 (Requires screen replacement)									FLX35-3537 (Requires screen replacement)														

FLX34B Series Performance Chart—25° (Metric)

Front Nozzle Positions			Nozzle Set 31		Nozzle Set 32		Nozzle Set 33		Nozzle Set 34		Nozzle Set 35		Nozzle Set 36		Nozzle Set 37		Nozzle Set 38						
			(Yellow) 102-0725	(Blue) 102-7001	(Brown) 102-0727	(Orange) 102-7002	(Green) 102-6908	(Gray) 102-0730	(Black) 102-4261	(Red) 102-4260	Yellow 102-6937	Blue 102-2925	Yellow 102-6937	Orange 102-2926	Yellow 102-6937	Red 102-2928	Yellow 102-6937	Beige 102-2929	Yellow 102-6937	Beige 102-2929	Yellow 102-6937	Red 102-6944	Yellow 102-6937
Front Nozzles 102-4335 Red Plug																							
Bar	kPa	kg/cm ²	rad/m	lpm	rad/m	lpm	rad/m	lpm	rad/m	lpm	rad/m	lpm	rad/m	lpm	rad/m	lpm	rad/m	lpm	rad/m	lpm			
3,5	345	3,52	17	49,2	18	58,7	—	—	—	—	—	—	—	—	—	—	—	—	—	—			
4,1	414	4,22	18	53,2	18	64,9	20	89,3	—	—	—	—	—	—	—	—	—	—	—	—			
4,8	483	4,92	18	58,7	19	68,9	21	99,2	22	113,6	24	135,1	—	—	—	—	—	—	—	—			
5,5	552	5,63	18	61,3	19	77,6	22	105,6	23	121,5	24	144,6	25	154,8	26	159,3	28	190,0	—	—			
6,2	621	6,33	19	66,2	20	83,1	22	112,2	24	128,9	25	153,1	26	164,1	27	168,4	28	199,8	—	—			
6,9	689	7,03	19	71,2	20	88,6	23	118,8	24	136,3	26	161,6	27	173,4	28	177,5	29	209,7	—	—			
Stator			102-6929 Blue									102-1940 White											
Conversions			FLX34-3134 (Requires screen replacement)									FLX34-3537 (Requires screen replacement)											

■ Not recommended at these pressures. Radius shown in meter.
 Toro recommends the use of a 30mm swing joint at flows over 95-LPM. Sprinkler radius data collected in Toro's zero wind test facility per ASAE standard S398.1.
 Actual site conditions must be considered when selecting the appropriate nozzle.
 All sprinklers are equipped with the selectable pilot valve that allows settings at 3,4; 4,5; 5,5; and 6,9 Bar.



FLEX800™ B SERIES GOLF ROTORS

FLX35-6B Series Performance Chart—25° (U.S.)

Base Pressure	Nozzle Set 30 (White) 102-2208		Nozzle Set 31 (Yellow) 102-4587		Nozzle Set 32 (Blue) 102-4588		Nozzle Set 33 (Brown) 102-4589		Nozzle Set 34 (Orange) 102-0728		Nozzle Set 35 (Green) 102-0729		Nozzle Set 36 (Gray) 102-0730		Nozzle Set 37 (Black) 102-4261		Nozzle Set 38 (Red) 102-6909		
	Blue	Gray	Blue	Gray	Red	Gray	Orange	Gray	Orange	Gray	Blue	Gray	Blue	Gray	Orange	Gray	Blue	Gray	
	102-2925	102-2910	102-2925	102-2910	102-2928	102-2910	102-2926	102-2910	102-2926	102-2910	102-2925	102-2910	102-2925	102-2910	102-2926	102-2910	102-2925	102-2910	
Back Nozzle 102-4335 Red Plug																			
PSI	Radius	GPM	Radius	GPM	Radius	GPM	Radius	GPM	Radius	GPM	Radius	GPM	Radius	GPM	Radius	GPM	Radius	GPM	
50	42	7.1	52	14.0	58	18.0	—	—	—	—	—	—	—	—	—	—	—	—	
60	43	7.9	54	15.2	60	19.5	66	21.9	—	—	—	—	—	—	—	—	—	—	
70	45	8.8	55	16.4	63	21.0	68	23.6	74	32.7	77	35.2	—	—	—	—	—	—	
80	46	9.6	57	17.4	65	22.6	70	25.3	77	35.1	79	37.7	84	39.6	86	43.4	90	47.5	
90	47	10.4	58	18.5	68	23.9	72	26.8	79	37.0	82	39.9	86	41.9	88	45.9	93	50.0	
100	48	11.2	59	19.4	70	25.2	74	28.2	80	38.9	84	41.8	88	44.1	90	48.4	95	52.5	
Stator	102-6929 Blue										102-1939 Yellow					102-1940 White			
Conversions											INF35-6-3134 (Requires screen replacement)					INF35-6-3537 (Requires screen replacement)			

FLX35B Series Performance Chart—25° (U.S.)

Front Nozzle Positions	Nozzle Set 30 (White Plug) 102-2208		Nozzle Set 31 (Yellow) 102-6906		Nozzle Set 32 (Blue) 102-0726		Nozzle Set 33 (Brown) 102-6907		Nozzle Set 34 (Orange) 102-0728		Nozzle Set 35 (Green) 102-6955		Nozzle Set 36 (Gray) 102-6935		Nozzle Set 37 (Black) 102-6936		Nozzle Set 38 (Red) 102-6909		
	Yellow	Beige	Yellow	Brown	Yellow	Yellow	Yellow	Yellow	Yellow	Yellow	Yellow	Green	Green	Green	Green	Green	Green	Green	
	102-5670	102-6942	102-5670	102-5671	102-5670	102-6884	102-5670	102-6884	102-5670	102-6884	102-5670	102-6885	102-6531	102-6885	102-6531	102-6885	102-6531	102-6885	
Back Nozzles 102-4335 Red Plug																			
PSI	Radius	GPM	Radius	GPM	Radius	GPM	Radius	GPM	Radius	GPM	Radius	GPM	Radius	GPM	Radius	GPM	Radius	GPM	
50	43	8.2	55	13.6	56	18.3	—	—	—	—	—	—	—	—	—	—	—	—	
60	44	9.3	56	15.0	58	20.1	63	24.2	—	—	—	—	—	—	—	—	—	—	
70	45	10.4	58	16.2	60	21.8	65	26.3	69	30.0	73	37.0	—	—	—	—	—	—	
80	46	11.5	59	17.3	62	23.3	67	28.0	71	32.1	75	39.6	78	42.9	80	48.6	85	50.6	
90	47	12.5	60	18.4	64	24.7	69	29.8	73	34.2	77	42.0	80	45.4	82	51.5	88	53.6	
100	47	13.4	61	19.3	65	26.0	70	31.4	74	35.9	79	44.2	81	48.8	83	54.2	90	56.3	
Stator	102-6929 Blue										102-1939 Yellow					102-1940 White			
Conversions											FLX35-3134 (Requires screen replacement)					FLX35-3537 (Requires screen replacement)			

FLX34B Series Performance Chart—25° (U.S.)

Front Nozzle Positions	Nozzle Set 31 (Yellow) 102-0725		Nozzle Set 32 (Blue) 102-7001		Nozzle Set 33 (Brown) 102-0727		Nozzle Set 34 (Orange) 102-7002		Nozzle Set 35 (Green) 102-6908		Nozzle Set 36 (Gray) 102-0730		Nozzle Set 37 (Black) 102-4261		Nozzle Set 38 (Red) 102-4260		
	Yellow	Blue	Yellow	Orange	Yellow	Red	Yellow	Beige	Yellow	Beige	Yellow	Red	Yellow	Gray	Yellow	Gray	
	102-6937	102-2925	102-6937	102-2926	102-6937	102-2928	102-6937	102-2929	102-6937	102-2929	102-6937	102-6944	102-6937	102-6945	102-6937	102-6945	
Front Nozzles 102-4335 Red Plug																	
PSI	Radius	GPM	Radius	GPM	Radius	GPM	Radius	GPM	Radius	GPM	Radius	GPM	Radius	GPM	Radius	GPM	
50	57	13.0	58	15.5	—	—	—	—	—	—	—	—	—	—	—	—	
60	58	14.1	60	17.2	67	23.6	—	—	—	—	—	—	—	—	—	—	
70	59	15.5	61	18.2	69	26.2	73	30.0	78	35.7	—	—	—	—	—	—	
80	60	16.2	63	20.5	72	27.9	76	32.1	80	38.2	83	40.9	85	42.1	91	50.2	
90	61	17.5	65	22.0	74	29.7	78	34.1	82	40.5	86	43.4	88	44.5	93	52.8	
100	62	18.8	66	23.4	75	31.4	79	36.0	84	42.7	88	45.8	91	46.9	95	55.4	
Stator	102-6929 Blue										102-1940 White						
Conversions	FLX34-3134 (Requires screen replacement)										FLX34-3537 (Requires screen replacement)						

■ Not recommended at these pressures. Radius shown in feet.

Toro recommends the use of a 1.25" swing joint at flows over 25-GPM. Sprinkler radius data collected in Toro's zero wind test facility per ASAE standard S398.1. Actual site conditions must be considered when selecting the appropriate nozzle.

All sprinklers are equipped with the selectable pilot valve that allows settings at 50, 65, 80 and 100 psi.





MAIN NOZZLE ADAPTER PERFORMANCE CHARTS

Intermediate Nozzle Performance Charts

102-2929 Beige		Trajectory		30°		25°		20°		15°		10°		7°	
Pressure		Flow		Radius		Radius		Radius		Radius		Radius		Radius	
PSI	BAR	LPM	GPM	Meters	Feet	Meters	Feet	Meters	Feet	Meters	Feet	Meters	Feet	Meters	Feet
50	3,4	30,7	8.1	17.4	53	17.1	52	16.4	50	15.7	48	14.8	45	13.8	42
60	4,1	33,7	8.9	18.7	57	18.4	56	17.4	53	16.7	51	15.4	47	14.8	45
65	4,5	35,2	9.3	19.0	58	18.4	56	17.7	54	16.7	51	16.1	49	15.1	46
70	4,8	36,3	9.6	19.4	59	18.7	57	18.4	56	17.4	53	16.4	50	15.7	48
80	5,5	39,0	10.3	20.0	61	19.7	60	19.0	58	18.4	56	17.4	53	16.4	50
90	6,2	41,3	10.9	20.7	63	20.0	61	19.4	59	18.7	57	17.7	54	16.7	51
100	6,9	43,5	11.5	21.3	65	20.7	63	19.7	60	19.0	58	18.0	55	16.7	51



102-2928 Red		Trajectory		30°		25°		20°		15°		10°		7°	
Pressure		Flow		Radius		Radius		Radius		Radius		Radius		Radius	
PSI	BAR	LPM	GPM	Meters	Feet	Meters	Feet	Meters	Feet	Meters	Feet	Meters	Feet	Meters	Feet
50	3,4	23,8	6.3	17.4	53	16.7	51	15.7	48	15.1	46	14.1	43	13.1	40
60	4,1	26,5	7.0	18.0	55	17.4	53	16.4	50	15.7	48	14.8	45	13.8	42
65	4,5	27,3	7.2	18.4	56	17.7	54	17.1	52	16.1	49	15.4	47	14.4	44
70	4,8	28,4	7.5	18.7	57	18.0	55	17.4	53	16.7	51	16.1	49	15.1	46
80	5,5	30,3	8.0	19.4	59	19.0	58	18.4	56	17.7	54	17.1	52	16.1	49
90	6,2	32,2	8.5	19.7	60	19.0	58	18.7	57	18.0	55	17.4	53	16.4	50
100	6,9	34,1	9.0	20.0	61	19.4	59	18.7	57	18.0	55	17.4	53	16.4	50



102-2927 Gray		Trajectory		30°		25°		20°		15°		10°		7°	
Pressure		Flow		Radius		Radius		Radius		Radius		Radius		Radius	
PSI	BAR	LPM	GPM	Meters	Feet	Meters	Feet	Meters	Feet	Meters	Feet	Meters	Feet	Meters	Feet
50	3,4	18,9	5.0	16.4	50	15.7	48	15.1	46	14.4	44	13.5	41	12.5	38
60	4,1	20,8	5.5	17.1	52	16.4	50	15.7	48	15.1	46	14.1	43	13.1	40
65	4,5	21,6	5.7	17.4	53	16.7	51	16.1	49	15.1	46	14.4	44	13.5	41
70	4,8	22,3	5.9	17.4	53	16.7	51	16.1	49	15.4	47	14.8	45	13.8	42
80	5,5	23,8	6.3	17.7	54	17.1	52	16.4	50	15.7	48	15.1	46	14.1	43
90	6,2	25,4	6.7	18.0	55	17.4	53	17.1	52	16.4	50	15.7	48	14.8	45
100	6,9	26,9	7.1	18.0	55	17.7	54	17.4	53	17.1	52	16.4	50	15.1	46



102-2926 Orange		Trajectory		30°		25°		20°		15°		10°		7°	
Pressure		Flow		Radius		Radius		Radius		Radius		Radius		Radius	
PSI	BAR	LPM	GPM	Meters	Feet	Meters	Feet	Meters	Feet	Meters	Feet	Meters	Feet	Meters	Feet
50	3,4	16,3	4.3	15.7	48	15.1	46	14.4	44	13.8	42	12.8	39	11.5	35
60	4,1	17,8	4.7	16.4	50	15.7	48	15.1	46	14.4	44	13.5	41	12.5	38
65	4,5	18,5	4.9	16.7	51	16.1	49	15.4	47	14.8	45	13.8	42	12.8	39
70	4,8	19,3	5.1	16.7	51	16.4	50	15.7	48	15.1	46	14.1	43	13.1	40
80	5,5	20,4	5.4	17.1	52	16.7	51	16.4	50	15.7	48	14.8	45	13.8	42
90	6,2	22,0	5.8	17.4	53	17.1	52	16.7	51	16.1	49	15.4	47	14.4	44
100	6,9	23,1	6.1	17.7	54	17.4	53	17.1	52	16.4	50	15.7	48	14.8	45



102-2925 Blue		Trajectory		30°		25°		20°		15°		10°		7°	
Pressure		Flow		Radius		Radius		Radius		Radius		Radius		Radius	
PSI	BAR	LPM	GPM	Meters	Feet	Meters	Feet	Meters	Feet	Meters	Feet	Meters	Feet	Meters	Feet
50	3,4	10,2	2.7	13.8	42	13.5	41	12.8	39	12.5	38	11.8	36	11.2	34
60	4,1	11,4	3.0	14.1	43	13.8	42	13.1	40	12.8	39	12.1	37	11.5	35
65	4,5	12,1	3.2	14.1	43	13.8	42	13.1	40	12.8	39	12.1	37	11.5	35
70	4,8	12,5	3.3	14.4	44	13.8	42	13.5	41	12.8	39	12.5	38	11.8	36
80	5,5	13,2	3.5	14.4	44	14.1	43	13.5	41	13.1	40	12.5	38	11.8	36
90	6,2	14,0	3.7	14.8	45	14.4	44	13.8	42	13.5	41	12.8	39	12.1	37
100	6,9	14,8	3.9	14.8	45	14.4	44	14.1	43	13.8	42	13.1	40	12.5	38



MAIN NOZZLE ADAPTER PERFORMANCE CHARTS

102-6885 Green		Trajectory		30°		25°		20°		15°		10°		7°	
Pressure		Flow		Radius		Radius		Radius		Radius		Radius		Radius	
PSI	BAR	LPM	GPM	Meters	Feet	Meters	Feet	Meters	Feet	Meters	Feet	Meters	Feet	Meters	Feet
50	3,4	20,4	5,4	16,7	51	16,4	50	15,7	48	14,8	45	13,8	42	12,8	39
60	4,1	22,3	5,9	17,1	52	16,7	51	16,1	49	15,1	46	14,1	43	13,5	41
65	4,5	23,1	6,1	17,1	52	16,7	51	16,4	50	15,4	47	14,4	44	13,8	42
70	4,8	23,8	6,3	17,4	53	17,1	52	16,4	50	15,4	47	14,4	44	13,8	42
80	5,5	25,4	6,7	17,4	53	17,1	52	16,7	51	15,7	48	14,8	45	14,1	43
90	6,2	26,9	7,1	17,7	54	17,4	53	17,1	52	16,4	50	15,4	47	14,8	45
100	6,9	28,0	7,4	18,0	55	18,0	55	17,7	54	17,1	52	16,1	49	15,4	47

102-6884 Yellow		Trajectory		30°		25°		20°		15°		10°		7°	
Pressure		Flow		Radius		Radius		Radius		Radius		Radius		Radius	
PSI	BAR	LPM	GPM	Meters	Feet	Meters	Feet	Meters	Feet	Meters	Feet	Meters	Feet	Meters	Feet
50	3,4	15,5	4,1	15,7	48	15,4	47	14,8	45	13,5	41	12,5	38	11,5	35
60	4,1	17,0	4,5	16,1	49	15,7	48	15,4	47	14,4	44	13,5	41	12,5	38
65	4,5	17,8	4,7	16,4	50	16,1	49	15,7	48	14,8	45	13,8	42	12,8	39
70	4,8	18,2	4,8	16,4	50	16,1	49	15,7	48	14,8	45	14,1	43	13,1	40
80	5,5	19,3	5,1	16,7	51	16,4	50	16,1	49	15,4	47	14,4	44	13,5	41
90	6,2	20,4	5,4	17,4	53	17,1	52	16,4	50	15,7	48	14,8	45	13,8	42
100	6,9	22,0	5,8	17,7	54	17,4	53	16,7	51	16,1	49	15,1	46	14,1	43

102-6883 Brown		Trajectory		30°		25°		20°		15°		10°		7°	
Pressure		Flow		Radius		Radius		Radius		Radius		Radius		Radius	
PSI	BAR	LPM	GPM	Meters	Feet	Meters	Feet	Meters	Feet	Meters	Feet	Meters	Feet	Meters	Feet
50	3,4	9,1	2,4	13,5	41	13,1	40	12,5	38	11,8	36	10,8	33	9,8	30
60	4,1	9,8	2,6	14,1	43	13,8	42	13,1	40	12,5	38	11,8	36	10,8	33
65	4,5	10,2	2,7	14,4	44	13,8	42	13,5	41	12,8	39	12,1	37	11,2	34
70	4,8	10,6	2,8	14,8	45	14,1	43	13,8	42	13,1	40	12,5	38	11,5	35
80	5,5	11,4	3,0	15,1	46	14,8	45	14,1	43	13,5	41	13,1	40	11,8	36
90	6,2	12,1	3,2	15,1	46	14,8	45	14,4	44	13,8	42	13,5	41	12,1	37
100	6,9	12,9	3,4	15,1	46	14,8	45	14,4	44	14,1	43	13,5	41	12,5	38

Inner Nozzle Performance Charts*

102-6937 Yellow		Trajectory		30°		25°		20°	
Pressure		Flow		Radius		Radius		Radius	
PSI	BAR	LPM	GPM	Meters	Feet	Meters	Feet	Meters	Feet
50	3,4	14,0	3,7	8,5	26	7,9	24	6,6	20
60	4,1	15,1	4,0	9,2	28	8,2	25	7,2	22
65	4,5	15,9	4,2	9,2	28	8,2	25	7,2	22
70	4,8	16,7	4,4	9,2	28	8,5	26	7,5	23
80	5,5	17,8	4,7	9,2	28	8,5	26	7,9	24
90	6,2	18,9	5,0	9,5	29	8,9	27	8,2	25
100	6,9	19,7	5,2	9,8	30	9,5	29	8,9	27

102-6531 Green		Trajectory		30°		25°		20°	
Pressure		Flow		Radius		Radius		Radius	
PSI	BAR	LPM	GPM	Meters	Feet	Meters	Feet	Meters	Feet
50	3,4	15,1	4,0	10,5	32	9,8	30	8,5	26
60	4,1	16,3	4,3	11,2	34	10,2	31	8,9	27
65	4,5	17,0	4,5	11,2	34	10,2	31	8,9	27
70	4,8	17,8	4,7	11,2	34	10,2	31	9,2	28
80	5,5	18,9	5,0	11,2	34	10,5	32	9,5	29
90	6,2	20,1	5,3	11,2	34	10,5	32	9,5	29
100	6,9	21,2	5,6	11,5	35	10,8	33	9,8	30



* Not recommended below 20°



FLEX800™ R SERIES CONVERSION UPGRADES



Learn more at
Toro.com



The Toro FLEX800™ R Series Conversion Upgrades enable customers with existing Rain Bird® Eagle™ 900 and 1100 Series sprinklers to upgrade to Toro's industry leading sprinkler technology. The benefits of upgrading include the patented TruJectory™ adjustment, full and part circle in the same sprinkler, the ability to ratchet the riser and clutch the nozzle base, and an extra 3,81cm (1.5") pop-up height.

Features & Benefits



Specifications



Performance Data



Rain Bird
Eagle 900



← Adds 3,81cm (1.5")
of pop-up height →



Rain Bird
Eagle 900 upgraded
with Toro R Series
upgrade assembly
and optional Spike
Guard solenoid/
adapter



Toro has designed and manufactured this product to fit within a sprinkler housing made by Rain Bird Corporation, but Toro's product is not manufactured by or affiliated with Rain Bird. Rain Bird is a registered trademark of Rain Bird Corporation.

TORO.



FLEX800™ R SERIES CONVERSION UPGRADES

Features & Benefits

- ① **Industry's Largest Nozzle Selection**
Nozzles from 12,8 – 30,5m (42' to 100') radius plus a wide assortment of back nozzles lets you put the precise amount of water exactly where you need it.
- ② **Ratcheting riser**
Align part circle quickly and easily or adjust watering locations to suit seasonal needs. (only FLX55-6RB and FLX55RB).
- ③ **Dual Trajectory**
The 25° setting provides maximum distance of throw and the 15° setting provides improved wind performance, radius reduction and obstacle avoidance (FLX54RB & FLX55RB).
- ④ **True Part- and Full-Circle in One – (40° - 330° part circle)**
These sprinklers can be full circle today and part circle tomorrow allowing you to simply and economically adjust the area of coverage to match your seasonal needs or meet water rationing mandates (FLX55-6RB & FLX55RB).



FLX55-6RB

FLX55RB

FLX54RB



Industry's Largest Nozzle Selection



Ratcheting riser



Dual Trajectory



True Part and Full-Circle in One

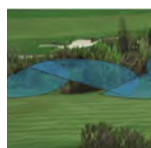

Toro has designed and manufactured this product to fit within a sprinkler housing made by Rain Bird Corporation, but Toro's product is not manufactured by or affiliated with Rain Bird. Rain Bird is a registered trademark of Rain Bird Corporation.

FLEX800™ R SERIES CONVERSION UPGRADES



SPECIFICATIONS

Operational

- Ratcheting riser allows riser positioning without riser removal.
- Recommended Operating Pressure Range: 4,1 6,9 Bar (60-100 psi) (maximum – 10,3 Bar (150 psi) and minimum – 2,7 Bar (40 psi)
- Radius reduction screw for radius refinement
- Riser pull-up feature simplifies servicing
- Yardage marker capable
- 8,26cm (3.25") pop-up clears tall grasses

Nozzles

- 4 main nozzle combinations included provides a wide range of radius and flow capabilities.
- Back nozzle capable (FLX55-6RB & FLX55RB)
- Two additional front nozzle positions (FLX54RB only)
- Nozzle base clutching (FLX55-6RB & FLX55RB) allows nozzle base movement by hand
- All nozzles threaded from the front with no disassembly required.



Specifying Information—R Series Conversion Assemblies

Model Number	Description
FLX55-6RB-5154	R Series Conversion with FLX55-6 riser assembly and low flow nozzle set #51 - #54
FLX55-6RB-5558	R Series Conversion with FLX55-6 riser assembly and high flow nozzle set #55 - #58
FLX55RB-5154	R Series Conversion with FLX55 riser assembly and low flow nozzle set #51 - #54
FLX55RB-5558	R Series Conversion with FLX55 riser assembly and high flow nozzle set #55 - #58
FLX54RB-5154	R Series Conversion with FLX54 riser assembly and low flow nozzle set #51 - #54
FLX54RB-5558	R Series Conversion with FLX54 riser assembly and high flow nozzle set #55 - #58

Specifying Information—R Series Solenoid Adaptors

Model Number	Description
SPIKEGUARD-RB	Toro solenoid adaptor with Spike Guard™ solenoid for Rain Bird Eagle 700, 900 or 1100 Series sprinklers

Toro® has designed and manufactured this product to fit within a sprinkler housing made by Rain Bird® Corporation, but Toro's product is not manufactured by or affiliated with Rain Bird. Rain Bird is a registered trademark of Rain Bird Corporation.



MAIN NOZZLE DATA

FLX55-6RB-5154 Performance Chart—(Metric)										FLX55-6RB-5558 Performance Chart—(Metric)									
Front Nozzle Positions	Nozzle Set 51 (Yellow) 102-4587		Nozzle Set 52 (Blue) 102-4588		Nozzle Set 53 (Brown) 102-4589		Nozzle Set 54 (Orange) 102-0728		Nozzle Set 55 (Green) 102-0729		Nozzle Set 56 (Gray) 102-0730		Nozzle Set 57 (Black) 102-4261		Nozzle Set 58 (Red) 102-4260				
	Blue 102-2925	Gray 102-2910	Red 102-2928	Gray 102-2910	Orange 102-2926	Gray 102-2910	Orange 102-2926	Gray 102-2910	Blue 102-2925	Gray 102-2910	Blue 102-2925	Gray 102-2910	Orange 102-2926	Gray 102-2910	Blue 102-2925	Gray 102-2910			
	Red Plug 102-4335		Red Plug 102-4335		Red Plug 102-4335		Red Plug 102-4335		Red Plug 102-4335		Red Plug 102-4335		Red Plug 102-4335		Red Plug 102-4335				
Bar	kPa	kg/cm ²	rad/m	lpm	rad/m	lpm	rad/m	lpm	rad/m	lpm	rad/m	lpm	rad/m	lpm	rad/m	lpm	rad/m	lpm	
4,1	414	4,22	16,8	60,9	19,2	76,8	21,0	88,6	22,9	118,5	—	—	—	—	—	—	—	—	
4,8	483	4,92	17,1	65,9	20,1	82,5	21,3	95,8	23,2	127,9	—	—	—	—	—	—	—	—	
5,5	552	5,63	17,4	70,0	20,7	88,2	21,9	102,2	23,5	136,3	24,4	148,0	25,9	155,2	26,8	171,9	28,0	188,1	
6,2	621	6,33	17,7	73,4	21,3	92,7	22,9	107,9	24,1	144,2	25,3	157,1	26,5	164,7	27,7	182,5	28,6	199,9	
6,9	689	7,03	18,0	77,6	21,9	98,0	23,2	113,6	24,4	152,2	26,2	165,4	27,4	173,0	28,6	191,5	29,3	209,3	
Stator		102-1939 Yellow								102-1940 White									
Conversion		FLX55-6RB-5154								FLX55-6RB-5558									

FLX55-6RB-5154 Performance Chart—(U.S.)										FLX55-6RB-5558 Performance Chart—(U.S.)									
Front Nozzle Positions	Nozzle Set 51 (Yellow) 102-4587		Nozzle Set 52 (Blue) 102-4588		Nozzle Set 53 (Brown) 102-4589		Nozzle Set 54 (Orange) 102-0728		Nozzle Set 55 (Green) 102-0729		Nozzle Set 56 (Gray) 102-0730		Nozzle Set 57 (Black) 102-4261		Nozzle Set 58 (Red) 102-4260				
	Blue 102-2925	Gray 102-2910	Red 102-2928	Gray 102-2910	Orange 102-2926	Gray 102-2910	Orange 102-2926	Gray 102-2910	Blue 102-2925	Gray 102-2910	Blue 102-2925	Gray 102-2910	Orange 102-2926	Gray 102-2910	Blue 102-2925	Gray 102-2910			
	Red Plug 102-4335		Red Plug 102-4335		Red Plug 102-4335		Red Plug 102-4335		Red Plug 102-4335		Red Plug 102-4335		Red Plug 102-4335		Red Plug 102-4335				
PSI	rad/ft	gpm	rad/ft	gpm	rad/ft	gpm	rad/ft	gpm	rad/ft	gpm	rad/ft	gpm	rad/ft	gpm	rad/ft	gpm	rad/ft	gpm	
60	55	16.1	63	20.3	69	23.4	75	31.3	—	—	—	—	—	—	—	—	—	—	
70	56	17.4	66	21.8	70	25.3	76	33.8	—	—	—	—	—	—	—	—	—	—	
80	57	18.5	68	23.3	72	27.0	77	36.0	80	39.1	85	41.0	88	45.4	92	49.7	94	52.8	
90	58	19.4	70	24.5	75	28.5	79	38.1	83	41.5	87	43.5	91	48.2	94	50.6	96	55.3	
100	59	20.5	72	25.9	76	30.0	80	40.2	86	43.7	90	45.7	94	50.6	96	55.3	96	55.3	
Stator		102-1939 Yellow								102-1940 White									
Conversion		FLX55-6RB-5154								FLX55-6RB-5558									



MAIN NOZZLE DATA

FLX55RB-5154 Performance Chart—(Metric)										FLX55RB-5558 Performance Chart—(Metric)								
Front Nozzle Positions			Nozzle Set 51 (Yellow) 102-6906		Nozzle Set 52 (Blue) 102-0726		Nozzle Set 53 (Brown) 102-6907		Nozzle Set 54 (Orange) 102-0728		Nozzle Set 55 (Green) 102-6955		Nozzle Set 56 (Gray) 102-6935		5Nozzle Set 57 (Black) 102-6936		Nozzle Set 58 (Red) 102-6909	
			Yellow 102-5670	Brown 102-5671	Yellow 102-5670	Yellow 102-6884	Yellow 102-5670	Yellow 102-6884	Yellow 102-5670	Yellow 102-6884	Yellow 102-5670	Green 102-6885	Green 102-6531	Green 102-6885	Green 102-6531	Green 102-6885	Green 102-6531	Green 102-6885
Back Nozzle Positions			Red Plug 102-4335	Red Plug 102-4335	Red Plug 102-4335	Red Plug 102-4335	Red Plug 102-4335	Red Plug 102-4335	Red Plug 102-4335	Red Plug 102-4335	Red Plug 102-4335	Red Plug 102-4335	Red Plug 102-4335	Red Plug 102-4335	Red Plug 102-4335	Red Plug 102-4335	Red Plug 102-4335	Red Plug 102-4335
Bar	kPa	kg/cm ²	rad/m	lpm	rad/m	lpm	rad/m	lpm	rad/m	lpm	rad/m	lpm	rad/m	lpm	rad/m	lpm	rad/m	lpm
4.1	414	4.22	17.1	57.5	17.4	76.1	20.1	92.0	20.7	106.0	—	—	—	—	—	—	—	—
4.8	483	4.92	17.7	62.5	18.3	82.1	20.4	99.2	21.6	115.1	—	—	—	—	—	—	—	—
5.5	552	5.63	18.0	66.2	18.9	87.4	20.7	105.2	21.9	120.0	23.2	150.3	24.4	163.2	25.3	182.5	25.9	200.6
6.2	621	6.33	18.3	69.7	19.5	92.7	21.6	109.0	22.6	130.6	23.8	163.2	24.7	170.7	26.2	193.8	26.5	212.0
6.9	689	7.03	18.6	73.1	20.1	95.8	21.9	114.7	22.9	138.2	24.4	172.2	25.0	185.5	27.4	206.3	27.1	223.3
Stator			102-1939 Yellow								102-1940 White							
Conversion			FLX55RB-5154								FLX55RB-5558							

FLX55RB-5154 Performance Chart—(U.S.)										FLX55RB-5558 Performance Chart—(U.S.)								
Front Nozzle Positions			Nozzle Set 51 (Yellow) 102-6906		Nozzle Set 52 (Blue) 102-0726		Nozzle Set 53 (Brown) 102-6907		Nozzle Set 54 (Orange) 102-0728		Nozzle Set 55 (Green) 102-6955		Nozzle Set 56 (Gray) 102-6935		5Nozzle Set 57 (Black) 102-6936		Nozzle Set 58 (Red) 102-6909	
			Yellow 102-5670	Brown 102-5671	Yellow 102-5670	Yellow 102-6884	Yellow 102-5670	Yellow 102-6884	Yellow 102-5670	Yellow 102-6884	Yellow 102-5670	Green 102-6885	Green 102-6531	Green 102-6885	Green 102-6531	Green 102-6885	Green 102-6531	Green 102-6885
Back Nozzle Positions			Red Plug 102-4335	Red Plug 102-4335	Red Plug 102-4335	Red Plug 102-4335	Red Plug 102-4335	Red Plug 102-4335	Red Plug 102-4335	Red Plug 102-4335	Red Plug 102-4335	Red Plug 102-4335	Red Plug 102-4335	Red Plug 102-4335	Red Plug 102-4335	Red Plug 102-4335	Red Plug 102-4335	Red Plug 102-4335
PSI	rad/ft	gpm	rad/ft	gpm	rad/ft	gpm	rad/ft	gpm	rad/ft	gpm	rad/ft	gpm	rad/ft	gpm	rad/ft	gpm	rad/ft	gpm
60	56	15.2	57	20.1	66	24.3	68	28.0	—	—	—	—	—	—	—	—	—	—
70	58	16.5	60	21.7	67	26.2	71	30.4	—	—	—	—	—	—	—	—	—	—
80	59	17.5	62	23.1	68	27.8	72	31.7	76	39.7	80	43.1	83	48.2	85	53.0	87	56.0
90	60	18.4	64	24.5	71	28.8	74	34.5	78	43.1	81	45.1	86	51.2	87	56.0	89	59.0
100	61	19.3	66	25.3	72	30.3	75	36.5	80	45.5	82	49.0	90	54.5	89	59.0	91	60.0
Stator			102-1939 Yellow								102-1940 White							
Conversion			FLX55RB-5154								FLX55RB-5558							



MAIN NOZZLE DATA

FLX54RB-5154 Performance Chart—(Metric)											FLX54RB-5558 Performance Chart—(Metric)							
Front Nozzle Positions		Nozzle Set 51 (Yellow) 102-0725		Nozzle Set 52 (Blue) 102-7001		Nozzle Set 53 (Brown) 102-0727		Nozzle Set 54 (Orange) 102-7002		Nozzle Set 55 (Green) 102-6908		Nozzle Set 56 (Gray) 102-0730		Nozzle Set 57 (Black) 102-4261		Nozzle Set 58 (Red) 102-4260		
		Red Plug 102-4335	Red Plug 102-4335	Red Plug 102-4335	Red Plug 102-4335	Red Plug 102-4335	Red Plug 102-4335	Red Plug 102-4335	Red Plug 102-4335	Red Plug 102-4335	Red Plug 102-4335	Red Plug 102-4335	Red Plug 102-4335	Red Plug 102-4335	Red Plug 102-4335	Brown 102-6883	Red Plug 102-4335	Brown 102-6883
Back Nozzle Positions		Yellow 102-6937	Blue 102-2925	Yellow 102-6937	Orange 102-2926	Yellow 102-6937	Red 102-2928	Yellow 102-6937	Beige 102-2929	Yellow 102-6937	Beige 102-2929	Yellow 102-6937	Red 102-2928	Yellow 102-6937	Gray 102-4965	Yellow 102-6937	Gray 102-4965	
Bar	kPa	kg/cm ²	rad/m	lpm	rad/m	lpm	rad/m	lpm	rad/m	lpm	rad/m	lpm	rad/m	lpm	rad/m	lpm	rad/m	lpm
4,1	414	4,22	18,0	55,3	18,9	65,9	20,7	92,0	21,6	106,7	—	—	—	—	—	—	—	—
4,8	483	4,92	18,3	59,4	19,2	71,2	21,3	99,6	22,9	115,8	—	—	—	—	—	—	—	—
5,5	552	5,63	18,6	62,1	19,5	75,7	21,9	104,5	23,8	123,4	25,3	149,5	25,9	161,6	26,5	173,8	27,7	190,0
6,2	621	6,33	18,9	67,4	20,1	80,6	22,6	113,2	24,4	131,4	25,9	157,5	26,8	170,0	27,4	183,6	28,3	199,9
6,9	689	7,03	19,2	68,5	20,4	89,3	22,9	115,1	24,7	138,9	26,5	165,4	27,4	177,2	28,3	193,8	29,0	209,7
Stator		102-6929 Blue									102-1940 White							
Conversion		FLX54RB-5154									FLX54RB-5558							

Not recommended at these pressures. Radius shown in metres.
 Toro recommends the use of a 3,18cm (1.25") swing joint at flows over 95-LPM (25-GPM). Sprinkler radius data collected in Toro's zero wind test facility per ASAE standard S398.1. Actual site conditions must be considered when selecting the appropriate nozzle.

FLX54RB-5154 Performance Chart—(U.S.)											FLX54RB-5558 Performance Chart—(U.S.)							
Front Nozzle Positions		Nozzle Set 51 (Yellow) 102-0725		Nozzle Set 52 (Blue) 102-7001		Nozzle Set 53 (Brown) 102-0727		Nozzle Set 54 (Orange) 102-7002		Nozzle Set 55 (Green) 102-6908		Nozzle Set 56 (Gray) 102-0730		Nozzle Set 57 (Black) 102-4261		Nozzle Set 58 (Red) 102-4260		
		Red Plug 102-4335	Red Plug 102-4335	Red Plug 102-4335	Red Plug 102-4335	Red Plug 102-4335	Red Plug 102-4335	Red Plug 102-4335	Red Plug 102-4335	Red Plug 102-4335	Red Plug 102-4335	Red Plug 102-4335	Red Plug 102-4335	Red Plug 102-4335	Red Plug 102-4335	Brown 102-6883	Red Plug 102-4335	Brown 102-6883
Back Nozzle Positions		Yellow 102-6937	Blue 102-2925	Yellow 102-6937	Orange 102-2926	Yellow 102-6937	Red 102-2928	Yellow 102-6937	Beige 102-2929	Yellow 102-6937	Beige 102-2929	Yellow 102-6937	Red 102-2928	Yellow 102-6937	Gray 102-4965	Yellow 102-6937	Gray 102-4965	
PSI	rad/ft	gpm	rad/ft	gpm	rad/ft	gpm	rad/ft	gpm	rad/ft	gpm	rad/ft	gpm	rad/ft	gpm	rad/ft	gpm	rad/ft	gpm
60	59	14,6	62	17,4	68	24,3	71	28,2	—	—	—	—	—	—	—	—	—	—
70	60	15,7	63	18,8	70	26,3	75	30,6	—	—	—	—	—	—	—	—	—	—
80	61	16,4	64	20,0	72	27,6	78	32,6	83	39,5	85	42,7	87	45,9	91	50,2	91	50,2
90	62	17,8	66	21,3	74	29,9	80	34,7	85	41,6	88	44,9	90	48,5	93	52,8	93	52,8
100	63	18,1	67	23,6	75	30,4	81	36,7	87	43,7	90	46,8	93	51,2	95	55,4	95	55,4
Stator		102-6929 Blue									102-1940 White							
Conversion		FLX54RB-5154									FLX54RB-5558							

Not recommended at these pressures. Radius shown in feet.
 Toro recommends the use of a 3,18cm (1.25") swing joint at flows over 25-GPM (95-LPM). Sprinkler radius data collected in Toro's zero wind test facility per ASAE standard S398.1. Actual site conditions must be considered when selecting the appropriate nozzle.



TORO® CONVERSION UPGRADE CHARTS

New Model	Arc	Trajectory	Radius	Flow-GPM	Models Being Replaced										
					634	664	734	764	765	864S	865S	834S	835S	DT34	DT35
FLX34-3134	Full Circle	25° or 15°	52' - 79'	12.9 - 34.9	X	X	X	X	X	X	X	X	X	X	X
FLX34-3537	Full Circle	25° or 15°	67' - 91'	32.1 - 46.9	X	X	X	X	X	X	X	X	X	X	X
FLX35-3134	Part/Full Circle	25° or 15°	52' - 74'	13.6 - 34.1			1	X	X	X	X	X	X	X	X
FLX35-3537	Part/Full Circle	25° or 15°	69' - 83'	33.1 - 47.3			1	X	X	X	X	X	X	X	X
FLX35-6-3134	Part/Full Circle	30° - 7°	46' - 80'	15.5 - 37.0			1	X	X	X	X	X	X	X	X
FLX35-6-3537	Part/Full Circle	30° - 7°	59' - 92'	32.4 - 45.3			1	X	X	X	X	X	X	X	X

1. Must have ribbed bodies manufactured after 1992 to use Part/Full circles.

New Model	Arc	Trajectory	Radius	Flow-GPM	Models Being Replaced													
					654	655	670	684	690	754	784	785	884S	885S	854S	855S	DT54	DT55
FLX54-5154	Full Circle	25° or 15°	58' - 81'	13.2 - 36.7	2	2	2	2	4	2	2	2	X	X	X	X	X	X
FLX54-5558	Full Circle	25° or 15°	79' - 95'	34.2 - 55.4	2	2	2	2	4	2	2	2	X	X	X	X	X	X
FLX54-59	Full Circle	25° or 15°	96' - 99'	55.6 - 61.8	2	2	2	2	4	2	2	2	X	X	X	X	X	X
FLX55-5154	Part/Full Circle	25° or 15°	55' - 75'	14.0 - 34.5					4	2	2	2	X	X	X	X	X	X
FLX55-5558	Part/Full Circle	25° or 15°	73' - 90'	35.3 - 53.9					4	2	2	2	X	X	X	X	X	X
FLX55-59	Part/Full Circle	25° or 15°	82' - 92'	57.2 - 61.3					4	2	2	2	X	X	X	X	X	X
FLX55-6-5154	Part/Full Circle	30° - 7°	46' - 80'	13.9 - 38.2					4	2	2	2	X	X	X	X	X	X
FLX55-6-5558	Part/Full Circle	30° - 7°	59' - 95'	33.8 - 51.1					4	2	2	2	X	X	X	X	X	X
FLX55-6-59	Part/Full Circle	30° - 7°	77' - 100'	57.0 - 61.1					4	2	2	2	X	X	X	X	X	X
FLX55-5154R	Part/Full Circle	25° or 15°	55' - 75'	14.0 - 34.5	3	3	3	3		3								
FLX55-5558R	Part/Full Circle	25° or 15°	73' - 90'	35.3 - 53.9	3	3	3	3		3								
FLX55-59R	Part/Full Circle	25° or 15°	82' - 92'	57.2 - 61.3	3	3	3	3		3								
FLX55-6-5154R	Part/Full Circle	30° - 7°	46' - 80'	13.9 - 38.2	3	3	3	3		3								
FLX55-6-5558R	Part/Full Circle	30° - 7°	59' - 95'	33.8 - 51.1	3	3	3	3		3								
FLX55-6-59R	Part/Full Circle	30° - 7°	77' - 100'	57.0 - 61.1	3	3	3	3		3								





- 2. Requires the separate purchase and use of 102-0950 conversion adapter.
- 3. Use the "R" Series (Ribless body) conversion for bodies dated prior to 1992.
- 4. Requires the separate purchase and use of 102-5011 690 conversion adapter.





MAINLESS AND BACK NOZZLE DATA





FLX55-6RB Series Mainless Nozzle Performance Data—(Metric)

			 Blue - Plug - Gray 102-2925 102-2208 102-2910		 Orange - Plug - Gray 102-2926 - 102-2208 - 102-2910		 Red - Plug - Gray 102-2928 - 102-2208 - 102-2910		 Gray - Plug - Gray 102-2910 - 102-2208 - 102-2910		 Gray - Plug - Gray 102-2930 - 102-2208 - 102-2910	
Bar	kPa	kg/cm ²	Radius	LPM	Radius	LPM	Radius	LPM	Radius	LPM	Radius	LPM
4,5	448	4,6	14,0	32,9	14,0	39,4	15,2	46,9	12,8	38,6	14,3	52,6
SOR			5:02		4:16		3:36		4:19		4:06	
5,5	552	5,6	14,0	36,3	14,3	43,5	16,2	51,9	13,4	42,4	15,5	57,9
SOR			4:22		3:40		3:03		3:53		3:40	

FLX55-6RB Series Mainless Nozzle Performance Data—(U.S.)

			Blue - Plug - Gray 102-2925 102-2208 102-2910		Orange - Plug - Gray 102-2926 - 102-2208 - 102-2910		Red - Plug - Gray 102-2928 - 102-2208 - 102-2910		Gray - Plug - Gray 102-2910 - 102-2208 - 102-2910		Gray - Plug - Gray 102-2930 - 102-2208 - 102-2910	
PSI	Radius	GPM	Radius	GPM	Radius	GPM	Radius	GPM	Radius	GPM	Radius	GPM
65	46	8,7	46	10,4	50	12,4	42	10,2	47	13,9		
SOR			5:02		4:16		3:36		4:19		4:06	
80	46	9,6	47	11,5	53	13,7	44	11,2	51	15,3		
SOR			4:22		3:40		3:03		3:53		3:40	

FLX55RB Mainless Nozzle Performance Data—(Metric)

			 Green Plug Grey 102-6531 102-2208 102-2910		 Green Plug Green 102-6531 102-2208 102-6885		 Green Plug Red 102-6531 102-2208 102-2928		 Green Plug Beige 102-6531 102-2208 102-2929	
Bar	kPa	kg/cm ²	Radius	LPM	Radius	LPM	Radius	LPM	Radius	LPM
4,5	448	4,6	10,4	39,4	13,4	38,6	14,6	43,5	15,2	51,1
SOR			3:40		3:50		3:25		2:40	
5,5	552	5,6	11,3	43,9	13,4	43,2	14,6	48,8	15,2	56,8
SOR			3:15		3:25		3:00		2:30	

FLX55RB Mainless Nozzle Performance Data—(U.S.)

PSI	Radius	GPM	Radius	GPM	Radius	GPM	Radius	GPM		
65	34	10,4	44	10,2	48	11,5	50	13,5		
SOR			3:40		3:50		3:25		2:40	
80	37	11,6	44	11,4	48	12,9	50	15,0		
SOR			3:15		3:25		3:00		2:30	

Requires the low-flow stator 102-6929 for indicated rotation speeds.
SOR: Speed of rotation



MAINLESS AND BACK NOZZLE DATA

Back Nozzle Performance Data—(Metric)

Nozzles			4,5 Bar 448 kPa 4,6 kg/cm2	5,5 Bar 552 kPa 5,6 kg/cm2			
Part #	Description	Color	Radius - m	LPM	Radius - m	LPM	Profile
102-6937	Inner Nozzle with Yellow Restrictor	Yellow/White	8,8	14,0	9,2	15,5	
102-6531	Inner Nozzle with White Restrictor	Green/White	9,5	16,3	10,1	17,4	
102-2135	Inner Nozzle with White Restrictor	White/White	7,6	15,5	7,9	17,0	
102-2136	Inner nozzle assy w/ yel restrictor	Yellow/White	7,3	14,4	7,6	15,5	
102-6883	Intermediate Nozzle	Brown	11,6	10,6	11,6	10,6	
102-6884	Intermediate Nozzle	Yellow	12,5	15,5	13,1	17,0	
102-6885	Intermediate Nozzle	Green	12,8	20,4	13,7	22,7	
102-2925	Intermediate Nozzle	Blue	12,2	10,6	12,8	12,1	
102-2926	Intermediate Nozzle	Orange	13,4	16,3	13,7	18,2	
102-2927	Intermediate Nozzle	Gray	14,0	19,3	14,3	20,4	
102-2928	Intermediate Nozzle	Red	14,6	24,6	15,3	26,5	
102-2929	Intermediate Nozzle	Beige	15,6	30,7	16,2	34,4	

Back Nozzle Performance Data—(U.S.)

Nozzles			65 PSI		80 PSI		
Part #	Description	Color	Radius	GPM	Radius	GPM	Profile
102-6937	Inner Nozzle w/ Yellow Restrictor	Yellow/White	29	3.7	30	4.1	
102-6531	Inner Nozzle w/ White Restrictor	Green/White	31	4.3	33	4.6	
102-6883	Intermediate Nozzle	Brown	38	2.8	38	2.8	
102-6884	Intermediate Nozzle	Yellow	41	4.1	43	4.5	
102-6885	Intermediate Nozzle	Green	42	5.4	45	6.0	
102-2925	Intermediate Nozzle	Blue	40	2.8	42	3.2	
102-2926	Intermediate Nozzle	Orange	44	4.3	45	4.8	
102-2927	Intermediate Nozzle	Gray	46	5.1	47	5.4	
102-2928	Intermediate Nozzle	Red	48	6.5	50	7.0	
102-2929	Intermediate Nozzle	Beige	51	8.1	53	9.1	



T7 SERIES ROTORS



Learn more at
Toro.com

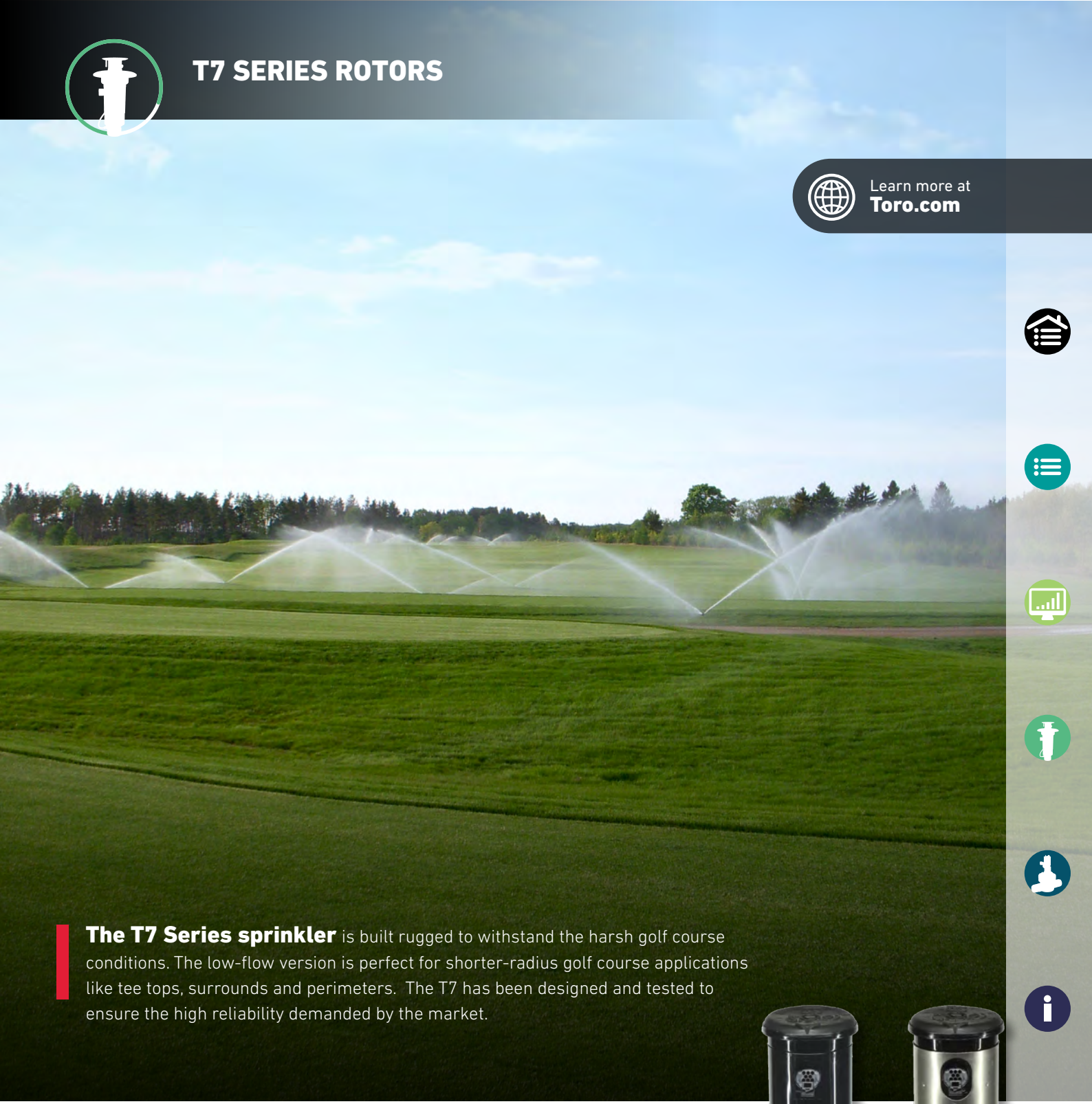

The T7 Series sprinkler is built rugged to withstand the harsh golf course conditions. The low-flow version is perfect for shorter-radius golf course applications like tee tops, surrounds and perimeters. The T7 has been designed and tested to ensure the high reliability demanded by the market.

Features & Benefits



Specifications



Performance Data



There are several model choices available for the T7 Series sprinklers:



Plastic or stainless steel models



Low-Flow or High-Flow models



Effluent water indicator models



T7 SERIES ROTORS



Features & Benefits

- 1 **Water is Evenly Distributed**
High efficiency nozzles with single port design ensure water is evenly distributed across the pattern.
- 2 **Versatility**
Available in standard and low-flow models to meet your application needs.
- 3 **Vandal and Abuse Resistant**
The Smart Arc memory safely returns the sprinkler to previously set arc even when turned beyond arc borders.
- 4 **Clears Tall Grasses**
The 14,61cm (5.75") pop-up ensures proper spray pattern and nozzle distribution uniformity even in taller grasses.
- 5 **Additional Features**
 - Standard check valve
 - Radius reduction screw – up to 25%
 - Threaded cap-retained riser assembly
 - Variable reversing stator
 - Slip clutch
 - Riser pull-up feature – adjustment/pull-up tool supplied
 - Locking cap screw
- 6 **Model Choices**
 - Plastic or stainless steel models
 - Low-Flow or High-Flow models
 - Effluent water indicator models



Top Arc Indication
Arc setting indicator on top of the rotor allows for easy wet or dry adjustments. Part or full-circle from 45° to 360°.

Operating Specifications

- Precipitation rate: 7,6 - 14,0mm (.30 - .55") per hour
- Radius: Low-flow models: 11,6 - 16,2m (38'-53')
- High-flow models: 14,0 - 25,0m (46'-83');
- Flow rate: Low-flow models: 6,4-49,2 LPM (1.7-13.0 GPM)
High-flow models: 25,4-116 LPM (6.8-30.5 GPM)
- Operating pressure range: 2,8-7,0 Bar (40-100 psi)
- Inlet size: 25mm (1") threaded NPT or 25mm (1") BSP
- Nozzle trajectory: 25°
- Arc adjustment: 45°-335° and 360° (unidirectional at 360°)

Additional Features

- Two nozzle trees:
- Low flow: 6 nozzles (2, 3, 4.5, 6, 7.5 and 9)
- High flow: 7 nozzles (7, 9, 12, 16, 20, 24 and 27)
- Nozzle support/breakup screw

Options Available

- Stainless steel riser

Dimensions

- Pop-up height to nozzle: 127mm (5")
- Body height: 222mm (8.75")
- Rubber cover diameter: 57mm (2.25")
- Body diameter: 70mm (2.75")

Warranty

- Two years; Five years when installed with Toro Swing Joints



Specifying Information—T7 Sprinkler

T7PXX-XXXX			
Descrip.	Optional	Thread	Optional
T7P	SS	XX	L
T7P—Sports Rotor	SS—Stainless Steel Riser	02—NPT Thread 42—ACME 52—BSP	L—Low Flow

Example: A low flow T7P sprinkler with a stainless steel riser and ACME threads would be specified as T7PSS-42L



T7 SERIES ROTORS

T7 Sports Rotor Nozzle Performance Data - Low Flow—Metric

Nozzle	Pressure (Bar)	Flow (LPM)	Radius (m)	Precip mm/hr ■	Precip mm/hr ▲
2.0	2,8	6,5	12,2	2,78	3,17
	3,4	7,4	12,8	3,15	3,59
	4,1	8,2	12,8	3,32	3,78
	4,8	8,9	12,5	3,61	4,11
	5,5	9,6	12,8	3,88	4,43
	6,2	10,3	12,5	3,94	4,50
	6,9	10,9	12,5	4,19	4,78
3.0	2,8	9,2	12,5	3,91	4,46
	3,4	10,5	12,8	4,23	4,83
	4,1	11,7	12,5	4,51	5,14
	4,8	12,8	12,5	4,92	5,61
	5,5	13,8	12,8	5,05	5,76
	6,2	14,7	12,5	5,15	5,87
	6,9	15,4	13,1	5,37	6,12
4.5	2,8	15,4	11,6	6,89	7,86
	3,4	17,6	12,5	6,77	7,72
	4,1	19,6	12,5	7,52	8,58
	4,8	21,3	12,8	7,82	8,92
	5,5	23,0	12,8	8,43	9,61
	6,2	24,6	13,1	8,59	9,79
	6,9	26,0	13,1	9,10	10,38
6.0	2,8	18,6	13,1	6,51	7,42
	3,4	21,3	14,0	6,51	7,42
	4,1	23,7	14,6	6,66	7,59
	4,8	26,7	15,2	7,18	8,19
	5,5	27,9	14,9	7,51	8,56
	6,2	29,8	15,2	7,70	8,78
	6,9	31,7	15,2	8,19	9,34
7.5	2,8	21,9	13,4	7,30	8,33
	3,4	25,1	14,0	7,66	8,74
	4,1	27,9	14,6	7,82	8,92
	4,8	30,5	15,2	8,20	9,35
	5,5	33,0	15,5	8,54	9,74
	6,2	35,8	15,8	9,26	10,55
	6,9	37,4	15,8	8,95	10,20
9.0	2,8	27,7	13,7	8,85	10,10
	3,4	31,9	14,9	8,60	9,80
	4,1	35,5	15,5	8,83	10,07
	4,8	39,5	16,5	9,08	10,36
	5,5	42,7	16,8	9,11	10,39
	6,2	45,6	16,8	9,74	11,11
	6,9	48,2	17,1	9,94	11,33

Radius shown in meters. Data based on 360°.

T7 Sports Rotor Nozzle Performance Data - Low Flow—U.S.

Nozzle	Pressure (PSI)	Flow (GPM)	Radius (FT)	Precip (in/hr) ▲	Precip (in/hr) ■
2.0	40	1.73	40	0.25	0.22
	50	1.96	42	0.29	0.25
	60	2.17	42	0.30	0.26
	70	2.36	41	0.33	0.28
	80	2.54	42	0.35	0.31
	90	2.71	41	0.36	0.31
	100	2.88	41	0.38	0.33
	3.0*	40	2.43	41	0.36
50		2.77	42	0.39	0.33
60		3.10	41	0.41	0.36
70		3.38	41	0.45	0.39
80		3.64	42	0.46	0.40
90		3.89	41	0.47	0.41
100		4.06	43	0.49	0.42
4.5		40	4.07	38	0.63
	50	4.65	41	0.62	0.53
	60	5.17	41	0.68	0.59
	70	5.64	42	0.71	0.62
	80	6.08	42	0.77	0.66
	90	6.49	43	0.78	0.68
	100	6.88	43	0.83	0.72
	6.0	40	4.92	43	0.59
50		5.63	46	0.59	0.51
60		6.27	48	0.61	0.52
70		7.05	50	0.65	0.57
80		7.37	49	0.68	0.59
90		7.87	50	0.70	0.61
100		8.37	50	0.74	0.64
7.5		40	5.78	44	0.66
	50	6.63	46	0.70	0.60
	60	7.37	48	0.71	0.62
	70	8.05	50	0.75	0.65
	80	8.73	51	0.78	0.67
	90	9.46	52	0.84	0.73
	100	9.89	52	0.81	0.70
	9.0	40	7.33	45	0.81
50		8.44	49	0.78	0.68
60		9.39	51	0.80	0.70
70		10.43	54	0.83	0.72
80		11.27	55	0.83	0.72
90		12.05	55	0.89	0.77
100		12.74	56	0.90	0.78

* Pre-installed nozzle
Data based on 180°





T7 SERIES ROTORS

T7 Sports Rotor Nozzle Performance Data - High Flow—Metric

Nozzle	Pressure (Bar)	Flow (LPM)	Radius (m)	Precip mm/hr ■	Precip mm/hr ▲
7.0	2,8	25,8	14,1	7,87	8,97
	3,4	28,1	14,8	8,21	9,36
	4,1	30,7	14,9	8,60	9,81
	4,8	33,7	15,3	9,07	10,34
	5,5	36,6	15,8	9,09	10,37
	6,2	38,9	15,8	9,29	10,59
	6,9	41,1	16,3	9,10	10,37
9.0	2,8	28,5	14,4	8,35	9,52
	3,4	31,2	15,4	8,07	9,20
	4,1	33,7	15,3	8,38	9,55
	4,8	37,1	15,8	8,87	10,12
	5,5	39,7	16,4	8,80	10,04
	6,2	42,4	16,3	9,06	10,33
	6,9	44,8	16,5	9,23	10,52
12.0	2,8	37,7	15,3	9,74	11,10
	3,4	39,9	16,3	9,92	11,32
	4,1	43,6	17,3	10,04	11,45
	4,8	47,5	18,0	10,52	11,99
	5,5	51,1	18,2	10,92	12,45
	6,2	54,4	18,5	11,22	12,79
	6,9	57,5	19,2	11,43	13,03
16.0	2,8	50,8	16,0	11,68	13,32
	3,4	56,6	17,4	11,67	13,30
	4,1	59,8	18,3	11,48	13,09
	4,8	64,8	18,6	12,03	13,72
	5,5	69,7	19,4	12,10	13,80
	6,2	74,3	19,6	12,50	14,25
	6,9	78,7	20,0	12,82	14,62
20.0	2,8	61,0	15,8	14,02	15,99
	3,4	69,7	17,5	13,38	15,26
	4,1	74,1	18,6	13,29	15,16
	4,8	79,5	19,4	13,81	15,75
	5,5	85,5	20,2	13,07	14,90
	6,2	90,8	20,7	13,47	15,36
	6,9	95,7	21,4	13,78	15,71
24.0	2,8	58,5	16,4	13,99	15,95
	3,4	67,0	18,4	12,02	13,70
	4,1	74,8	19,4	12,18	13,88
	4,8	81,8	20,2	12,51	14,27
	5,5	88,2	20,8	12,69	14,47
	6,2	94,2	21,3	13,16	15,00
	6,9	99,6	22,0	12,76	14,55
27.0	2,8	73,3	16,8	15,66	17,86
	3,4	83,2	19,6	12,72	14,51
	4,1	90,2	21,6	11,56	13,18
	4,8	97,2	22,0	12,11	13,81
	5,5	103,5	22,3	12,55	14,31
	6,2	109,9	22,7	12,97	14,79
	6,9	115,5	22,9	13,27	15,13

T7 Sports Rotor Nozzle Performance Data - High Flow—U.S.

Nozzle	Pressure (PSI)	Flow (GPM)	Radius (FT)	Precip (in/hr) ▲	Precip (in/hr) ■
7.0	40	6.81	46.3	0.715	0.620
	50	7.41	48.7	0.746	0.646
	60	8.10	49.0	0.782	0.677
	70	8.90	50.3	0.824	0.714
	80	9.67	52.0	0.827	0.716
	90	10.27	52.0	0.845	0.732
	100	10.85	53.3	0.827	0.716
	9.0	40	7.54	47.3	0.759
50		8.25	50.7	0.734	0.635
60		8.91	50.3	0.762	0.660
70		9.81	52.0	0.807	0.699
80		10.49	53.7	0.800	0.693
90		11.20	53.3	0.823	0.713
100		11.83	54.0	0.839	0.727
12.0*		40	9.95	50.3	0.885
	50	10.55	53.3	0.902	0.781
	60	11.53	56.7	0.913	0.791
	70	12.54	59.0	0.956	0.828
	80	13.51	59.7	0.993	0.860
	90	14.38	60.7	1.020	0.883
	100	15.18	63.0	1.039	0.900
	16.0	40	13.42	52.3	1.062
50		14.96	57.0	1.061	0.919
60		15.79	60.0	1.044	0.904
70		17.13	61.0	1.094	0.948
80		18.41	63.7	1.100	0.953
90		19.64	64.3	1.136	0.984
100		20.80	65.7	1.166	1.009
20.0		40	16.10	52.0	1.275
	50	18.40	57.3	1.216	1.053
	60	19.56	61.0	1.209	1.047
	70	21.01	63.7	1.256	1.087
	80	22.58	66.3	1.188	1.029
	90	23.99	68.0	1.225	1.061
	100	25.29	70.3	1.253	1.085
	24.0	40	15.46	53.7	1.272
50		17.69	60.3	1.093	0.946
60		19.76	63.7	1.107	0.959
70		21.61	66.3	1.138	0.985
80		23.29	68.3	1.154	0.999
90		24.87	70.0	1.196	1.036
100		26.30	72.3	1.160	1.005
27.0		40	19.37	55.0	1.424
	50	21.98	64.3	1.157	1.002
	60	23.82	71.0	1.051	0.910
	70	25.67	72.3	1.101	0.954
	80	27.34	73.0	1.141	0.988
	90	29.03	74.3	1.179	1.021
	100	30.52	75.0	1.207	1.045

Radius shown in meters. Data based on 360°.





690 SERIES ROTORS



Learn more at **Toro.com**



Features & Benefits



Specifications



Performance Data



For nearly 50 years the 690 Series has set the standard for durability and reliability in golf applications. Two 2-speed models provide a slower speed in the non-overlap areas and a faster speed in the overlap areas to provide a more balanced precipitation rate than traditional full circle sprinklers in these application which lowers system costs.

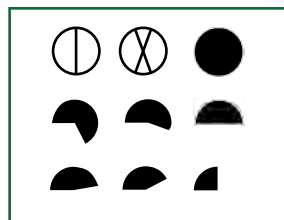

Fixed Arc Drives
Nine fixed arc drive assemblies ensure positive retention of the coverage area with no arc drift.





690 SERIES ROTORS

Features & Benefits

- 1 696 2-Speed Models**
Used in single row applications these sprinklers operate at a slower speed over the 60 degree non-overlap area and a faster speed over the 120 degree overlapped areas to provide a balanced application rate.
- 2 698 2-Speed Models**
Used in double row applications these sprinklers operate at a slower speed over the 180 degree non-overlap area and a faster speed over the 180 degree overlapped areas to provide a a balanced application rate.

- 3 Artificial Playing Surfaces**
Radius and flow capabilities are perfect for cooling and rinsing artificial playing surfaces.
- 4 Electric Valve In Head Models**
Electric valve in head models provide individual head control that ensures run times can match differing soil, turf and terrain watering requirements, pressure regulation to ensure all nozzles perform at the same pressure and manual ON-OFF-Auto control at the head.

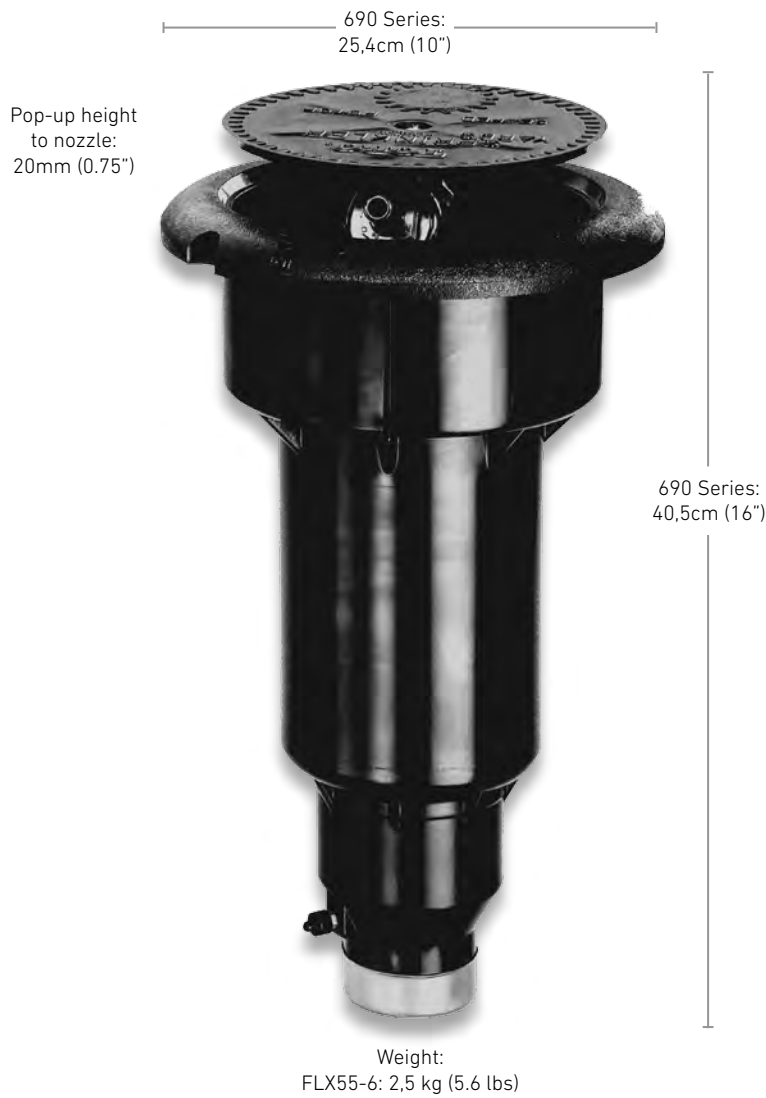

2-Speed Models
696



2-Speed Models
698



Artificial
Surfaces



Electric
Valve In Head

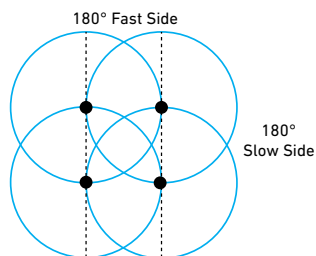
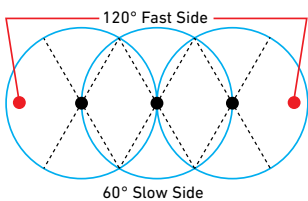

690 SERIES ROTORS



Operating Specifications

- Inlet: 3,8cm (1.5") NPT
- Radius: 26,5 – 32,9m (87' – 108')
- Flow Rate: 193,0 – 311,2 LPM (51,0 – 82,2 GPM)
- Recommended Operating Pressure Range:
 - 5,5 – 7,0 Bar (80 – 100 psi)
 - Maximum pressure: 10,3 Bar psi (150 psi)
 - Minimum pressure: 2,8 Bar (40 psi)
- Electric Valve-In-Head Solenoid: 24V ac, 50/60 Hz
 - Inrush: 60 Hz; 0,30 Amps
 - Holding: 60 Hz; 0,20 Amps
- Check-O-Matic: Maintains 11,2m (37') of elevation

Additional Features

- Manual control at the sprinkler, On-Off-Auto (electric)
- Time-proven, gear-drive design
- All internal components serviceable from the top of the sprinkler
- Durable engineering plastic and stainless steel construction
- Nine arc selections

Dimensions

- Body diameter: 25,4cm (10")
- Body height: 40,5cm (16")
- Weight: 2,5 kg (5.6 lbs)
- Pop-up height to nozzle: 20mm (0.75")

Warranty

- Two years; Five years when installed with Toro Swing Joints

690 Series Performance Chart—(Metric)

Base Pressure			Nozzle Set 90		Nozzle Set 91		Nozzle Set 92	
Bar	kPa	Kg/cm ²	Radius	LPM	Radius	LPM	Radius	LPM
5,5	550	5,61	26,5	193,0	29,3	231,3	30,5	280,1
6,9	690	7,04	27,4	216,1	30,5	278,2	32,9	311,2

Radius shown in meters.
Sprinkler radius of throw per ASAE standard S398.1.

690 Series Performance Chart—(U.S.)

Base Pressure		Nozzle Set 90		Nozzle Set 91		Nozzle Set 92	
psi	Radius	GPM	Radius	GPM	Radius	GPM	
80	87	51.0	96	61.2	100	74.0	
100	90	57.1	100	73.5	108	82.2	

Radius shown in feet.
Sprinkler radius of throw per ASAE standard S398.1.

Specifying Information—690

69X-0X-XXX			
Arc	Valve-In-Head Type	Nozzle	Pressure Regulation*
69X	0X	XX	X
1—90° 2—180° 4—Full-circle 6—Full-circle, 2-speed (60°–120°) 8—Full-circle, 2-speed (180°–180°)	A—150° B—165° C—195° D—210°	1—Normally Open Hydraulic 2—Check-O-Matic 6—Electric	90 91 92
			8—5,5 bar (80 psi) 1—6,9 bar (100 psi)

Example: When specifying a 690 Series Sprinkler with a 180° arc, electric valve-in-head, #91 nozzle, and pressure regulation at 5,5 bar (80 psi), you would specify: 692-06-918

*Electric models only.



590GF SERIES SPRAYS



Learn more at
Toro.com

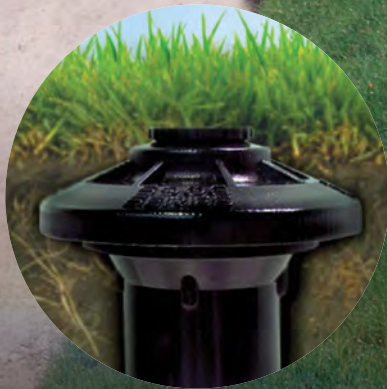

Flanged Cap
Flanged cap installs below grade to stabilize the body position and maintain optimum nozzle performance.

Features & Benefits



Specifications



Toro's 590GF Series is the first spray head designed specifically for golf course irrigation with enhanced water management capabilities.

The 590GF is built for the tough golf course environment, including harsh debris situations like top-dressing and sand, high water pressures, and daily mower and foot traffic. The 590GF is perfect around bunkers, on small tee boxes, and around the clubhouse. And with its patented X-Flow technology, the 590GF has a built-in shutoff device should a nozzle be damaged or removed and it's standard check valve feature minimizes low head drainage.



590GF-4

590GF-6

590GF-12

590GF SERIES SPRAYS



Features & Benefits

- 1 Nozzle Options**
In addition to the full line of Toro MPR, T-VAN and specialty nozzles the 590GF accepts the revolutionary Precision™ Spray and Precision™ Rotating Series nozzles with optimized distribution uniformity that provides exceptional turf conditions with minimal water usage.
- 2 Designed Flush Rate**
Sprinkler flushes during pop-up and retraction clearing debris from around the riser to eliminate stick-ups and ensure positive sealing and retraction.
- 3 X-Flow® Shut Off Device**
The X-Flow shut off feature stops the flow of water if the nozzle is damaged or removed to eliminate flooding, water waste and soil erosion.
- 4 Prevent Low Head Drainage**
The standard check valve prevents low head drainage with up to 3 meters (10') of elevation change minimizing soil erosion and water waste.

With X-Flow
Eliminates water waste, soil erosion and flooding

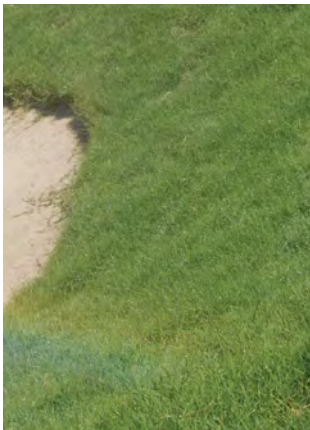

Without X-Flow
Water waste, soil erosion and flooding occur

Specifications

Operating Specifications

- Radius: 0,6 – 7,9m (2' – 26')
- Recommended pressure range: 1,7 – 3,4 Bar (25-50 psi) maximum – 5,2 Bar (75 psi)
- Flow rate: 0,2 – 17,8LPM (0.05 – 4.71 GPM)
- 2 GPM flush rate

Additional Features

- Stainless steel retraction spring
- All bodies shipped with flush plug in place
- Ratcheting riser feature for arc adjustment

Dimensions

- Body diameter:
 - 34,9mm (1.375") on 4P and 6P
 - 41,275mm (1.625") on 12P
- Cap diameter: 50,8mm (2")
- Inlet: 12,7mm (0.5") female-threaded

Warranty

- Two years; Five years when installed with Toro Swing Joints



Risers and Extenders



570-6X

- Male-inlet threads install onto any 590GF sprinkler or to provide a 15,2cm (6") extension
- Maximum pressure: 5,2 Bar (75 psi)

570SR-6 and 570SR-18 Risers

- 12,7mm (0.5") male-threaded inlet for installation on pipe fittings
- Maximum pressure: 5,2 Bar (75 psi)
- Height: 15,2cm and 45,7 (6" and 18")

Specifying Information – 590GF Series Sprays

69X-0X-XXX	
Model Number	Description
590GF-4	10,2cm (4") Pop-Up
590GF-6	15,2cm (6") Pop-Up
590GF-12	30,5cm (12") Pop-Up



PRECISION™ SERIES SPRAY NOZZLES



Learn more at [Toro.com](https://www.toro.com)



Toro's Precision™ Series Spray Nozzles are the most complete and efficient spray nozzle line available to help irrigation professionals manage water use. The Precision™ Series Spray Nozzles' 25mm/hr. (1"/hr.) precipitation rate ensures that water is applied more slowly and evenly. Now also available in pressure-compensating versions, further enhancing the best-in-class spray nozzle in the industry.

Features & Benefits



Specifications



Performance Data



PSN with PCD Performs Under Pressure!

UP TO
33%
WATER SAVINGS

Pressure Compensation Device

The elastomeric PCD disk opens and closes in response to changes in inlet pressure to maintain optimal nozzle performance. Recommended for use on systems operating above 2,8 Bar (40 psi), PCD models can easily be identified by the red Toro lettering across the top of the nozzle.





PRECISION™ SERIES SPRAY NOZZLES

Features & Benefits

- ① **Patented H²O Chip Technology**
Using patented H²O chip technology – and no moving parts – each Precision™ Series Spray Nozzle creates one or more high frequency oscillating streams to achieve the desired arc and radius with one-third less water usage.
- ② **Maximize Irrigation Efficiency**
Precision™ Series Spray Nozzles deliver an industry first 25mm/hr (1"/hr) precipitation rate, which better matches soil infiltration rate. This lower precipitation rate, along with high distribution uniformity make this the most efficient nozzle family from 1,5-4,6m (5'-15').
- ③ **Third-Party Performance Validation**
Precision™ Series Spray Nozzles have been tested and validated in the field and at the Center for Irrigation Technology (CIT).

- ④ **Pressure-Compensating**
Pressure-Compensating Precision™ Series Spray Nozzles maintain 25mm/hr. (1"/hr) precipitation rate and minimize misting for inlet pressures of more than 2,8 Bar (40 PSI), minimizing the need for a regulating head, at a fraction of the cost.
- ⑤ **Design and Retrofit Effectiveness**
The lower flow rate of Precision™ Series Spray Nozzles maximizes design efficiency and saves on overall material costs by using fewer valves and less controller stations. In addition, existing systems with low pressure can be fixed with a simple retrofit of the existing high-flow nozzle.

① 

② 

④ 
PSN with PCD Nozzle

⑤ 
Competitor's High Flow Nozzle

③ 



**Based on internal flow rate test data in Riverside, CA.*

PRECISION™ SERIES SPRAY NOZZLES



Operating Specifications

- Radius: 1,5-4,6m (5'-15')
- Operating Pressure Range: 1,4-5,2 Bar (20-75 psi)
- Arc Options: 60°, 90°, 120°, 150°, 180°, 210°, 240°, 270°, 360°
- Side & Corner Specialty Patterns
- Fit Toro® or Irritrol®, Rain Bird® and Hunter® Spray Bodies



Specifications

- Operating Specifications (with PCD)
- Radius: 1,5-4,6m (5'-15')
 - Operating pressure range: 2,8-5,2 Bar (40-75 psi)
 - Recommended Pressure: 3,5 Bar (50 psi)
 - Flow Rate: 0,2-9,6 LPM (0.06-2.4 GPM)
 - Nozzle trajectory:
 - 1,5m (5'): 5°
 - 2,4m (8'): 10°
 - 3,0m (10'): 15°
 - 3,7m (12'): 20°
 - 4,6m (15'): 27°
 - Corner and Side Strips: 20°

Additional Features

- Radius reduction 25% maximum
- Color coded for radius on top of the nozzle
- Precipitation rate ≤ 25mm/hour (≤ 1"/hour)
- Maintains precipitation rate as radius is reduced up to max of 25%
- Matched precipitation rate within radius families
- Matched precipitation rates between radius families
- Screen attached to nozzle for easy insertion into the spray body
- Works on all spray bodies

Warranty

- Two years



Pressure-Compensating Precision™ Series Nozzle Model List

Desc.	1,5m (5') "O" Nozzle (Red)		2,4m (8') "O" Nozzle (Green)		3,0m (10') "O" Nozzle (Blue)		3,7m (12') "O" Nozzle (Brown)		4,6m (15') "O" Nozzle (Black)		Special Patterns (Grey)	
	Male	Female	Male	Female	Male	Female	Male	Female	Male	Female	Male	Female
Arc												
60°	O-T-5-60P	O-5-60P	O-T-8-60P	O-8-60P	O-T-10-60P	O-10-60P	O-T-12-60P	O-12-60P	O-T-15-60P	O-15-60P	O-T-4X9-RCSP	O-4X9-RCSP
90°	O-T-5-QP	O-5-QP	O-T-8-Q P	O-8-QP	O-T-10-QP	O-10-QP	O-T-12-QP	O-12-QP	O-T-15-QP	O-15-QP	O-T-4X9-LCSP	O-4X9-LCSP
120°	O-T-5-TP	O-5-TP	O-T-8-TP	O-8-TP	O-T-10-TP	O-10-TP	O-T-12-TP	O-12-TP	O-T-15-TP	O-15-TP	O-T-4X18-SSTP	O-4X18-SSTP
150°	O-T-5-150P	O-5-150P	O-T-8-150P	O-8-150P	O-T-10-150P	O-10-150P	O-T-12-150P	O-12-150P	O-T-15-150P	O-15-150P	O-T-4X15-RCSP	O-4X15-RCSP
180°	O-T-5-HP	O-5-HP	O-T-8-HP	O-8-HP	O-T-10-HP	O-10-HP	O-T-12-TQP	O-12-HP	O-T-15-HP	O-15-HP	O-T-4X15-LCSP	O-4X15-LCSP
210°	O-T-5-210P	O-5-210P	O-T-8-210P	O-8-210P	Q-T-10-210P	O-10-210P	O-T-12-210P	O-12-210P	O-T-15-210P	O-15-210P	O-T-4X30-SSTP	O-4X30-SSTP
240°	O-T-5-TTP	O-5-TTP	O-T-8-TTP	O-8-TTP	Q-T-10-TTP	Q-10-TTP	O-T-12-TTP	O-12-TTP	O-T-15-TTP	O-15-TTP		
270°	O-T-5-TQP	O-5-TQP	O-T-8-TQP	O-8-TQP	Q-T-10-TQP	Q-10-TQP	O-T-12-TQP	O-12-TQP	O-T-15-TQP	O-15-TQP		
360°	O-T-5-FP	O-5-FP	O-T-8-FP	O-8-FP	Q-T-10-FP	Q-10-FP	O-T-12-FP	O-12-FP	O-T-15-FP	O-15-FP		



Pressure-Compensating Precision™ Series Nozzle Model List

Desc.	1,5m (5') "O" Nozzle (Red)		2,4m (8') "O" Nozzle (Green)		3,0m (10') "O" Nozzle (Blue)		3,7m (12') "O" Nozzle (Brown)		4,6m (15') "O" Nozzle (Black)		Special Patterns (Grey)	
	Male	Female	Male	Female	Male	Female	Male	Female	Male	Female	Male	Female
Arc												
60°	O-T-5-60	O-5-60	O-T-8-60	O-8-60	O-T-10-60	O-10-60	O-T-12-60	O-12-60	O-T-15-60	O-15-60	O-T-4X9-RCS	O-4X9-RCS
90°	O-T-5-Q	O-5-Q	O-T-8-Q	O-8-Q	O-T-10-Q	O-10-Q	O-T-12-Q	O-12-Q	O-T-15-Q	O-15-Q	O-T-4X9-LCS	O-4X9-LCS
120°	O-T-5-T	O-5-T	O-T-8-T	O-8-T	O-T-10-T	O-10-T	O-T-12-T	O-12-T	O-T-15-T	O-15-T	O-T-4X18-SST	O-4X18-SST
150°	O-T-5-150	O-5-150	O-T-8-150	O-8-150	O-T-10-150	O-10-150	O-T-12-150	O-12-150	O-T-15-150	O-15-150	O-T-4X15-RCS	O-4X15-RCS
180°	O-T-5-H	O-5-H	O-T-8-H	O-8-H	O-T-10-H	O-10-H	O-T-12-TQ	O-12-H	O-T-15-H	O-15-H	O-T-4X15-LCS	O-4X15-LCS
210°	O-T-5-210	O-5-210	O-T-8-210	O-8-210	Q-T-10-210	O-10-210	O-T-12-210	O-12-210	O-T-15-210	O-15-210	O-T-4X30-SST	O-4X30-SST
240°	O-T-5-TT	O-5-TT	O-T-8-TT	O-8-TT	Q-T-10-TT	Q-10-TT	O-T-12-TT	O-12-TT	O-T-15-TT	O-15-TT		
270°	O-T-5-TQ	O-5-TQ	O-T-8-TQ	O-8-TQ	Q-T-10-TQ	Q-10-TQ	O-T-12-TQ	O-12-TQ	O-T-15-TQ	O-15-TQ		
360°	O-T-5-F	O-5-F	O-T-8-F	O-8-F	Q-T-10-F	Q-10-F	O-T-12-F	O-12-F	O-T-15-F	O-15-F		



Specifying Information—Precision™ Series Spray Nozzles

O-X-XXXX-XXX					
Nozzle	Thread	Radius	Arc	PCD	
O	X	XXXX	XXX	P	
O—1" Per Hour	T—Toro Male Threaded Nozzle Blank—Female Threaded Nozzle	5— 1,5m (5') 8— 2,4m (8') 10— 3,0m (10') 12— 3,7m (12') 15— 4,6m (15')	4X15— 1,2mX4,6m* (4'X15') 4X30— 1,2mX9,1m* (4'X30') 4X9— 1,2mX2,7m (4'X9') 4X18— 1,2mX5,5m (4'X18')	60 — 60** Q — 90° T — 120° 150 — 150** H — 180° 210 — 210** TT — 240° TQ — 270° F — 360° -Full Circle LCS — Left Corner RCS — Right Corner SST — Side Strip*	P—Pressure Compensating
Example: A female threaded Precision Series Spray with a spray radius of 3,7m (12') and a 90° arc would be specified as: O-12-QP Example 2: A male threaded Precision Series Spray with a spray radius of 3,0m (10') and a 180° arc would be specified as: O-T-10-HP					



PRECISION™ SERIES ROTATING NOZZLES



Learn more at
Toro.com



Based on the design of the world's leading gear-driven rotor for golf applications, the Precision™ Series Rotating Nozzle

powered by its proven planetary gear drive delivers wind-resistant, multi-stream, multi-trajectory patterns. Both the full circle and adjustable arc models deliver a radius range of 14 to 26 feet with exceptional uniformity and outstanding close-in watering, preventing the need to extend irrigation cycles to compensate for brown spots. The consistent matched precipitation rate of 0.55 inches per hour helps meet the needs of tight water windows.

Precision Series Rotating Nozzles supply matched precipitation with any arc and any radius from 4,3m-7,9m (14 to 26'). Water is applied slowly and evenly to reduce runoff and wasted water.

Features & Benefits



Specifications



Performance Data



Water Management Highlight

Air Relief Valve
Opens at the end of every watering cycle allowing clean air to enter the system and eliminate emitter clogging from siphoning.



Steps

Step-Up™ Technology

Step-Up™ Technology is designed to deliver high uniformity with matched precipitation for in-close watering all the way out to the furthest radius point. The unique "steps" create 15 streams, each designed to cover an area of the pattern.



PRECISION™ SERIES ROTATING NOZZLES

Features & Benefits

- ① **Gear-Driven**
Utilizes a proven planetary gear drive, variable stator and turbine to rotate the nozzle.
- ② **Matched Precipitation Rate of 14 mm/hr. (0.55"/hr.)**
These nozzles deliver water more slowly and evenly than standard spray nozzles. The precipitation rate of 14 mm/hr. (0.55"/hr.) helps prevent excess run times often set to stay within watering windows.
- ③ **Consistent Speed of Rotation**
The gear drive mechanism delivers a consistent speed of rotation regardless of system pressure and prevents product stalling at low pressure.

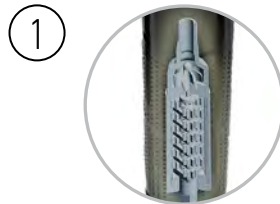

PRECISION™ SERIES ROTATING NOZZLES



PRN Visual Arc Adjustment



The unique adjustment method allows for pre-setting of arc by hand or tool before the nozzle is installed. Visual indicators allow the user to quickly adjust the arc pattern to the desired arc from 45°-270°. The adjustment band can be adjusted by hand or with the pre-included tool. The tool can be ordered separately as: PRNTOOL

Performance Data Precision™ Series Rotating Nozzles—Metric

Arc	Bar	LPM	Radius	Precip Rate (mm/hr)		Rotation
				■	▲	
45°	1,7	0,64	4,3	17,0	19,59	19,0
	2,1	0,87	4,6	20,0	23,09	17,0
	2,4	0,79	4,9	16,0	18,53	16,0
	3,1	1,06	5,5	16,9	19,52	15,0
	3,8	1,25	5,8	17,9	20,65	14,0
	4,5	1,48	6,7	15,8	18,20	14,0
90°	5,2	1,63	6,7	17,4	20,07	13,0
	1,7	1,63	4,9	16,4	18,97	14,0
	2,1	1,70	5,2	15,2	17,58	13,0
	2,4	2,04	5,8	14,6	16,89	13,0
	3,1	2,65	6,7	14,1	16,33	13,0
	3,8	2,99	7,0	14,6	16,87	13,0
120°	4,5	3,22	7,6	13,3	15,36	12,0
	5,2	3,48	7,6	14,4	16,62	12,0
	1,7	1,82	5,0	13,1	15,12	14,0
	2,1	2,23	5,2	15,0	17,29	12,0
	2,4	2,38	5,6	13,5	15,59	12,0
	3,1	3,48	6,7	13,9	16,10	12,0
180°	3,8	3,86	7,0	14,1	16,33	11,0
	4,5	4,20	7,3	14,1	16,32	11,0
	5,2	4,47	7,6	13,8	15,99	11,0
	1,7	3,14	4,6	18,0	20,83	12,0
	2,1	3,44	5,2	15,4	17,78	12,0
	2,4	4,01	5,8	14,4	16,58	12,0
240°	3,1	5,22	6,7	13,9	16,10	12,0
	3,8	5,83	7,0	14,2	16,44	11,0
	4,5	6,36	7,6	13,1	15,18	11,0
	5,2	6,85	7,9	13,1	15,12	10,0
	1,7	4,24	4,6	18,3	21,08	12,0
	2,1	4,58	4,9	17,3	20,02	12,0
270°	2,4	5,38	5,8	14,4	16,66	12,0
	3,1	6,47	6,4	14,2	16,42	12,0
	3,8	7,15	6,7	14,3	16,54	12,0
	4,5	7,61	7,0	13,9	16,09	11,0
	5,2	8,33	7,3	14,0	16,18	10,0
	1,7	4,09	4,3	17,9	20,69	11,0
360°	2,1	4,88	4,6	18,6	21,53	11,0
	2,4	5,19	5,5	13,7	15,88	11,0
	3,1	7,08	6,4	13,8	15,92	10,0
	3,8	8,06	6,7	14,3	16,52	10,0
	4,5	8,90	7,3	13,3	15,32	10,0
	5,2	9,84	7,6	13,5	15,62	10,0
360°	1,7	6,85	4,6	19,7	22,71	13,0
	2,1	8,18	5,5	16,3	18,82	13,0
	2,4	8,25	5,9	14,2	16,35	13,0
	3,1	11,13	6,8	14,3	16,54	13,0
	3,8	12,26	7,1	14,6	16,85	11,0
	4,5	13,17	7,4	14,4	16,64	11,0
5,2	13,93	7,8	13,7	15,85	11,0	

Specifications

Operating Specifications

- Radius: 4,3-7,9m (14'-26')
- Operating pressure range: 1,4-5,2 Bar (20-75 psi)
- Recommended Pressure: 2,8-3,5 Bar (40-50 psi)
- Flow Rate: 1,4-14 LPM (0.17-3.68 GPM)

Additional Features

- 15 unique streams with different trajectories
- Maximum height of 20° trajectory to fight through wind
- Threads onto nearly all sprayheads and shrub adapters (male or female)
- Pre-attached screen for easy installation
- Radius reduction up to 25% by turning set screw 90°
- Color coded to identify adjustable or full circle
- Precipitation rate = 14 mm/hr. (0.55"/hr.) on square spacing plans
- Maintains precipitation rate as radius is reduced
- Matched precipitation from 4,3-7,9m (14-26')
- Matched precipitation from 1,4-5,2 Bar (20-75 psi)
- Adjustable by hand or with included tool
- Consistent speed of rotation not affected by pressure

Warranty

- Five years

Precision Series Rotating Nozzle Model List

Male Threaded	Description
PRN-TA	Toro Threaded, 4,3-7,9m (14-26'), Adjustable from 45°-270°
PRN-TF	Toro Threaded, 4,3-7,9m (14-26'), Full-Circle
Female Threaded	Description
PRN-A	Female Threaded, 4,3-7,9m (14-26'), Adjustable from 45°-270°
PRN-F	Female Threaded, 4,3-7,9m (14-26'), Full-Circle

Specification Note:

Proper system flush prior to installation and primary filtration of 100 mesh is necessary to ensure reliable operation of this product.

Specifying Information—Precision Series Rotating Nozzle

PRN-XX		
Model	Thread	Model
PRN	X	X
PRN—Precision Rotating Nozzle	T—Male Thread Blank—Female Thread	A—Adjustable arc F—Full-circle
Example: A male threaded Precision Series Rotating nozzle with a 7,3m (24') radius and a 180° arc would be specified as: PRN-TA A female threaded Precision Series Rotating nozzle with a 6,1m (20') radius and 360° arc would be specified as: PRN-F		



SWING JOINTS



Learn more at
Toro.com

MINIMIZE LOW FRICTION LOSS

2,54 3,18 and 3,81 cm (1", 1.25" and 1.5") models are available to cover flows exceeding 80 gpm, and minimize friction loss to ensure optimum pressure is available at each sprinkler.

STANDARD 2X90 AND ULTRA 4X90 OUTLET CONFIGURATIONS

The standard 2x90 models provide two 90's at the outlet for alignment in two directions and the Ultra 4x90 models provide four 90's at the outlet for maximum alignment flexibility in four directions.

SADDLE AND GLUE TEE MODELS

Two swing joint types are available with 2" service tees included; glue tees for PVC piping applications and saddle tees for HDPE piping applications. Both tee styles are available with 2,54 3,18 and 3,81 cm (1", 1.25" and 1.5") double o-ring sealing outlets.

QUICK COUPLER MODELS

All swing joint styles are available with a quick coupler outlet that includes both an anti-rotation and position stabilizing feature to ensure the quick coupling valve stays secure during key installation and removal.



Features & Benefits



Specifications



Toro offers a full line of swing joints that cover all Golf sprinkler thread types.

Swing joints provide the flexibility to align the sprinkler to proper grade and level positioning to ensure optimum water use through maximum nozzle distribution uniformity.



*Durability And Reliability
Constructed from schedule 80 PVC for durability and provide double o-ring seals on all swing fittings to ensure a lifetime of reliability and leak free performance.*



SWING JOINTS



3,18cm (1.25") Female ACME x
2,54cm (1") Male ACME Adapter

Allows you to upgrade existing Rain Bird® Eagle 700 3,18cm (1.25") sprinklers to any Toro 800S or DT Series Sprinkler. P/N TA36-132

Additional Features

- Schedule 80 PVC construction
- Double o-ring swivel joints
- Low friction loss characteristics
- 21,7 bar (315 psi) pressure rating
- 65,7 bar (800 psi) burst pressure safety rating
- 2,54, 3,18 and 3,81cm (1", 1.25" and 1.5") models
- Standard models with 2X90 outlet configuration
- Ultra models with 4X90 outlet for maximum alignment flexibility
- 2 inlet fittings styles; ACME and BSP
- 2 outlet fitting styles; ACME and BSP
- 30,48, 40,64 and 45,72 cm (12", 16" and 18") lay lengths
- Quick coupler models w/ Dura-lock anti-rotation feature
- Compatible with all brands of service and saddle tees

Warranty

- Five years
- Toro Golf sprinkler warranty extended to 5 years when purchased and installed with a Toro Swing Joint.

Toro Tool Tip:

Use a 3,18cm (1.25") hole saw for the 2,54cm (1") Saddle Tee.

Use a 3,81cm (1.5") hole saw for the 3,18 (1.25") and 3,81cm (1.5") Saddles.



2,54, 3,18 and 3,81cm
(1", 1.25" and 1.5")



Standard 2x90
and Ultra 4x90



Quick Coupler



Glue tees, Saddle tees

Specifying Information—Toro Swing Joint

TSJ-XXXXXX-XX-X-XXX

Description	Inlet Size	Inlet Type	Size	Length	Number of Elbows	Outlet Size	Outlet Type
TSJ	XX	XX	XX	XX	X	XX	X
TSJ—Toro Swing Joint	10—2,54cm (1") 12—3,18cm (1.25") 15—3,8cm (1.5") 50—1,25cm (0.5") 75—1,9cm (0.75")	A—ACME thread ST—Saddle Tee B—BSP	Blank—same as inlet size 10—2,54cm (1") 12—3,18cm (1.25") 15—3,8cm (1.5")	8—20,32cm (8") Lay Length 12—30,48cm (12") Lay Length 16—40,64cm (16") Lay Length 18—45,72cm (18") Lay Length	3—Standard Unibody 4—Standard Unibody for Saddle Tees 5—Ultra Unibody 6—Ultra Unibody for Saddle Tees	10—2,54cm (1") 15—3,8cm (1.5")	M—MIPT (Male pipe thread) A—ACME thread Q—Quick Coupler, inlet size and size are different QC—Quick Coupler inlet size and size are the same B—BSP
Example: A Toro 3,18cm (1.25") Swing Joint with an 3,18cm (1.25") ACME inlet, 30,48cm (12") lay length, 3 elbows (standard uni-body) and 2,54cm (1") ACME outlet fitting would be specified as: TSJ-12A-12-3-10A							



SPRINKLER TOOLS



995-15 Selector tool

- All electric golf sprinklers
- Allows user to manually turn the sprinkler "ON", turn or leave it "OFF" or place it into the "AUTO" position awaiting a command from the controller

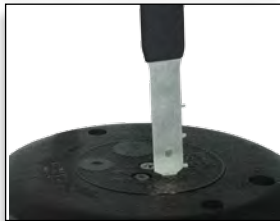

995-83 Multi Purpose tool

- All Golf sprinklers
- Riser pull up for INFINITY, FLEX800, DT and 800S Series
- Riser screen removal on all models.
- Upper snap ring remover on all models



Riser Removal Tools

- **995-06** drive assembly extraction tool 630, 650 and 690 models
 - Threads into the nozzle base and allows removal of the drive from the body
- **995-85** drive assembly extraction tool 730,760,780,860S,880S
 - Threads onto the drive output shaft and allows removal of the drive from the body



995-82 Arc adjustment tool, 2,38mm (3/32") Allen Wrench

- 765,785,865S,885S Arc adjustment of the part circle drives
- INFINITY, FLEX800, DT and 800S Series. Adjustment of the radius reduction screw



Valve Removal Tools

- **995-08** All 2,5cm (1") golf models and 640
- **995-09** All 3,8cm (1.5") models and 690.



Riser Hold Up Tools

- Allow for Nozzle Servicing
- **118-0954** Riser hold up tool, red
 - **995-55** all 700 models
 - **995-102** Universal hold up tool, all 700, 800S DT, INFINITY and FLEX800 models



995-100 Valve snap ring pliers with screen remover

- All Golf sprinklers Lower snap ring removal on all models
- Rock screen removal on all INFINITY, FLEX800, DT and 800S Series
- Valve removal on all models

Nut Drivers

- **995-105** 7,9mm (5/16") INFINITY", FLEX800, DT and 800S Series
TruJectory adjustment on INF5-6/FLX5-6 models
 - Inner, intermediate and back nozzle removal on all DT and 800S models
- **995-99** 15,9mm (5/8")
 - Series Dual trajectory selection
 - Main nozzle removal on all models
- **995-79** 11,1mm (7/16") 834S/854S pre August 2007
 - Inner, intermediate and back nozzle removal
 - 650/760/780/860S/880S
Inner, intermediate and back nozzle removal
- **995-81** 14,3mm (9/16") 760/780 Series Main nozzle removal
- **995-80** 12,7mm (1/2") 760/780/860S/880S Nozzle base jam nut removal
- **995-52** 6,4mm (1/4") 660/680 Drive plate nut removal
- **995-53** 9,5mm (3/8") 660/680 Cap nut removal



Valve Insertion Tools

Aligns and Installs Valve into the Body

- **995-xx** 640 VIH body
- **995-76** all 2,5cm (1") golf models
- **995-101** all 3,8cm (1.5") golf models
- **995-12** 690 body
- **995-20** 690 w/ rubber cover
- **118-1843** INF50 models
- **118-1844** INF30 models



PNOZZTOOL

Riser Pull Up Tool

- Used on 590GF sprays



PRNTTOOL

- Adjustment tool for Precision™ Series Rotating Nozzles
- Adjusts arc and radius



1026527

- Rotor adjustment tool





Learn more at
Toro.com

VALVES

va

Valves and Valve Boxes
Comparison Charts

220g

220G Brass
Series Valves

P220g

P220G
Series Valves

vb

Valve Boxes

db

Dry Boxes

NEW

470

470 Quick Coupler
Valves





Valve Comparison Chart

		Model	220G Series	P220G Series
		Page Number	116	119
		Flow Range	19-681 LPM (5.0-180 GPM)	19-681 LPM (5.0-180 GPM)
		Operating Pressure	0,7-15,2 Bar (10-220 PSI Max)	0,7-15,2 Bar (10-220 PSI Max)
Conditions	Electrically Activated Systems		X	X
	Pressure Regulated Systems		X	X
Sizes	25 mm (1")		X	X
	40 mm (1.5")		X	X
	50 mm (2")		X	X
Configurations	Angle		X	X
	Inline/Globe		X	X
Inlet/Outlet	Threaded (Female)		X	X
Features	Manual Flow Control		X	X
	Pressure Regulation		X	X
	Internal Manual Bleed		X	X
	External Manual Bleed (Flush)		X	X
Body Construction	Glass-filled Nylon			X
	Brass		X	
Warranty			2 Years	2 Years

220G BRASS SERIES VALVES



Learn more at
Toro.com



Features & Benefits



Specifications



The 220G Brass Series

Valves that provide extra durability in the most challenging environments on the course. With precise pressure regulation the optimum operating pressure and exact flow requirements are delivered to every sprinkler ensuring maximum efficiency and uniformity.



220G BRASS SERIES VALVES

Features & Benefits

- ① **EZReg® Pressure Regulating System**
Can be adjusted from 0,3-6,9 Bar (5-100 PSI) to provide the optimum operating pressure for every zone.
- ② **Spike Guard™ Solenoid**
With 20,000 volt lightning rating, it virtually eliminates the need for solenoid replacements. And with half the amperage draw of traditional solenoids you can run twice as many valves simultaneously, reduce the cost of wire during installation or increase the distance from controller to valve.

- ③ **Internal Manual Bleed**
Ensures the optimum pressure of the system even when being operated manually.
- ④ **Self Flushing And Serviceable Filter**
A 120 mesh stainless steel screen in the flow of water is continually being cleaned any time the valve is in operation. Serviceable from the side of the valve the filter can be removed without disassembly.

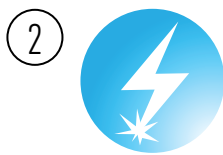

220G BRASS SERIES VALVES



Valve Wire Sizing Chart

Maximum One-way Distance (in ft.) Between Controller and Valve Using Spike-Guard™ Solenoid*

Ground Wire	Control Wire						
	18	16	14	12	10	8	6
18	2040	2520	2940	3280	3540	3720	3860
16	2520	3260	4000	4660	5220	5620	5920
14	2940	4000	5180	6360	7420	8300	8960
12	3280	4660	6360	8240	10100	11800	13180
10	3540	5220	7420	10100	13180	16060	18770
8	3720	5260	8300	11800	16060	20800	25540
6	3860	5960	8960	13180	18700	25540	33080

* Solenoid Model: 24 V ac
 Pressure: 10,3 Bar (150 psi)
 Voltage Drop: 4 V
 Minimum Operating Voltage: 20 V
 Amperage (peak) 0.12 A

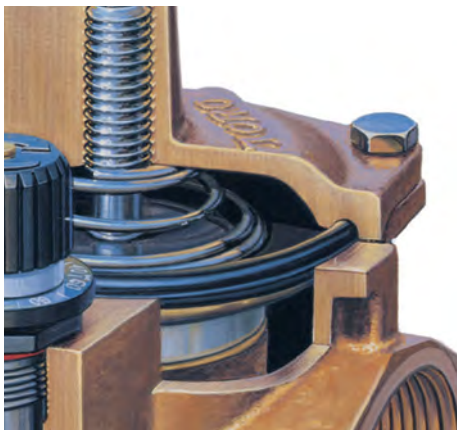

Fabric Reinforced Diaphragm
 Provides superior performance and extended life without tearing in high pressure applications.

Operating Specifications

- Flow Range:
 - 25mm (1"): 19 – 95 lpm (5 – 25 gpm)
 - 40mm (1.5"): 75 – 227 lpm (20 – 60 gpm)
 - 50mm (2"): 151 – 303 lpm (40 – 80 gpm)
- Operating Pressure (15,2 bar (220 psi) maximum pressure rating):
 - Electric — 0,7–15 Bar (10–220 psi)
- Pressure regulating:
 - Outlet: 0,3 - 6,9 bar (5 - 100 psi ± 3 psi)
 - Inlet: 0,7 - 15,2 bar (10 - 220 psi)
- Minimum pressure differential (between inlet and outlet) for pressure regulation: 0,7 Bar (10 psi)
- Burst pressure safety rating: 52 Bar (750 psi)
- Body style:
 - Globe valve – 25mm, 40mm, and 50mm (1", 1.5", 2") female threads
- Spike Guard™ Solenoid: 24 VAC (50/60 Hz) Standard
 - Inrush: 60 Hz; 0,12 amps
 - Holding: 60 Hz; 0,10 amps

Additional features

- Diaphragm stem guide
- Ingot brass and stainless steel construction
- Pressure regulates in electric and manual modes, serviceable under pressure
- Forward-flow design for more precise regulation
- Standard, built-in Schrader-type valve for downstream pressure verification
- Anti-vandal dust cap on pressure-regulating models
- No external tubing
- External manual bleed for system flushing
- Manual flow control: adjustable to zero flow
- Stainless steel diaphragm support ring for minimum wear
- Stainless steel solenoid seat for longer life and positive shutoff
- Low-power requirement for longer wire runs

Dimensions

- 25mm (1"): 146 x 127mm (5.75" H x 5" W)
- 40mm (1.5"): 165 x 152mm (6.5" H x 6" W)
- 50mm (2"): 191 x 178mm (7.5" H x 7" W)

Warranty

- Five years

220G Series Friction Loss Data (Metric—LPM)

Model - Electric	19	38	57	76	114	151	189	227	265	303	378	454	568	644	681	757	946	1136	1325
25mm (1")	0,14	0,17	0,10	0,17	0,38	0,61													
40mm (1.5")				0,27	0,29	0,32	0,34	0,36	0,38	0,50									
50mm (2")					0,07	0,14	0,14	0,17	0,21	0,24	0,41	0,52	0,69	0,83	0,97				

Notes: For optimum performance when designing a system, calculate total friction loss to ensure sufficient downstream pressure.
 For optimum regulation performance, size regulating valves toward the higher flow ranges. Flow rates are recommended not to exceed 0,34 Bar (5 psi) loss.

220 Series Friction Loss Data (English—GPM)

Model - Electric	5	10	15	20	30	40	50	60	70	80	100	120	150	170	180	200	250	300	350
1" (25mm)	2.0	2.5	1.5	2.5	5.5	8.9													
1.5" (40mm)				3.9	4.2	4.6	4.9	5.2	5.5	7.2									
2" (50mm)					1.0	2.0	2.0	2.5	3.0	3.5	6.0	7.5	10.0	12.0	14.0				

Notes: For optimum performance when designing a system, calculate total friction loss to ensure sufficient downstream pressure.
 For optimum regulation performance, size regulating valves toward the higher flow ranges. Flow rates are recommended not to exceed 0,34 Bar (5 psi) loss.

Specifying Information—220G Series

220G-XX-X-X			
Type	Body Style	Solenoid	Size
220G	XX	X	X
220G—220G Series Brass Valve	24—BSP, Electric, Pressure Regulated 27—NPT, Electric, Pressure Regulated	0—60 Hz Solenoid 5—50 Hz Solenoid 6—Less Solenoid	4—25mm (1") 6—40mm (1.5") 8—50mm (2")
Example: A 25mm (1") 220G Series brass electric valve with a 50 Hz solenoid BSP threads, would be specified as: 220G-24-54			

P220G SERIES VALVES



Learn more at
Toro.com



Features & Benefits



Specifications



The P220G Series provide a full family of plastic valves that can deliver the water to meet the challenging needs of today's courses. With precise pressure regulation these valves deliver the optimum pressure and flow requirements to every sprinkler on the zone ensuring maximum uniformity of the water to the turf.



P220G SERIES VALVES

Features & Benefits

- ① **EZReg® Pressure Regulating System**
Can be adjusted from 0,3-6,9 Bar (5-100 PSI) to deliver the optimum pressure for every need.
- ② **Spike Guard™ Solenoid**
With its 20,000 volt lightning rating, it virtually eliminates the need for solenoid replacements in high lightning environments.

- ③ **Internal Manual Bleed**
Ensures the optimum pressure of the system even when being operated manually.
- ④ **Double-beaded Fabric Reinforced Diaphragm**
Provides superior performance and extended life without tearing in high-pressure golf applications.



P220G SERIES VALVES



Valve Wire Sizing Chart

Maximum One-way Distance (in ft.) Between Controller and Valve Using Spike-Guard™ Solenoid*

Ground Wire	Control Wire						
	18	16	14	12	10	8	6
18	2040	2520	2940	3280	3540	3720	3860
16	2520	3260	4000	4660	5220	5620	5920
14	2940	4000	5180	6360	7420	8300	8960
12	3280	4660	6360	8240	10100	11800	13180
10	3540	5220	7420	10100	13180	16060	18770
8	3720	5260	8300	11800	16060	20800	25540
6	3860	5960	8960	13180	18700	25540	33080

* Solenoid Model: 24 V ac
 Pressure: 10,3 Bar (150 psi)
 Voltage Drop: 4 V
 Minimum Operating Voltage: 20 V
 Amperage (peak) 0.12 A

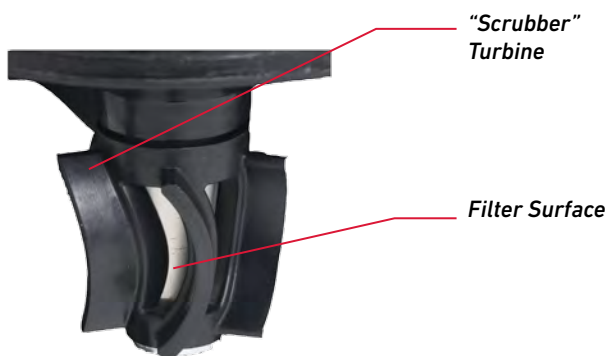

ACT™ System

Patent-pending Active Cleansing Technology – in which the turbine is constantly rotating to clean the metering/filtration area. This ensures that dirt, algae, chlorines, chloramines and water treated with ozone will not impede valve performance (P220GS only).

P220G Series Friction Loss Data—(Metric)

Model	Type	LPM Flow																					
		25	50	75	100	125	150	200	250	300	350	400	450	500	600	700	800	900	1000	1200	1400		
25mm (1")	Electric	0,15	0,13	0,17	0,31	0,41	0,48																
40mm (1.5")	Electric			0,32	0,33	0,36	0,37	0,42	0,47	0,55	0,64	0,79	1,02										
50mm (2")	Electric					0,09	0,14	0,15	0,19	0,24	0,35	0,44	0,51	0,59	0,75	1,00							

Notes: For optimum performance when designing a system, calculate total friction loss to ensure sufficient downstream pressure.
 For optimum regulation performance, size regulating valves toward the higher flow ranges.
 Flow rates are recommended not to exceed 0,3 bar loss. Values shown in bar.

P220G Series Friction Loss Data*—(U.S.)

Size	Configuration	GPM Flow																						
		5	10	20	30	40	50	60	70	80	90	100	110	120	130	140	150	180	200	225	250	275	300	
25mm (1")	Globe	4,00	4,20	3,20	4,10	7,20																		
	Angle	4,00	4,20	3,10	2,70	4,80																		
40mm (1.5")	Globe				1,60	2,30	3,60	5,20	7,00	9,20	11,20	13,60	16,40											
	Angle				1,30	1,60	2,80	4,00	5,50	7,10	8,90	10,90	13,80											
50mm (2")	Globe									2,10	2,70	3,30	4,00	4,80	5,60	6,50	7,50	8,70						
	Angle									1,20	1,60	2,00	2,40	2,80	3,30	3,90	4,40	5,20						

Notes: For optimum performance when designing a system, be sure to calculate total friction loss to ensure sufficient downstream pressure.
 For optimum regulation performance, size regulating valves toward the higher flow ranges.
 Flow rates are recommended not to exceed 5 psi loss. Values shown in psi.

Specifying Information—P220G Series

P220G-27-OXXXX			
Type	Body Style	Size	Optional
P220G	27	X	XXX
P220G—P220G Series Plastic Valve	27—NPT, Pressure-regulated 0,3-6,9 bar (5-100 PSI) 24—BSP, Pressure Regulated 0,3-6,9 bar (5-100 PSI)	4—25mm (1") 6—40mm (1.5") 8—50mm (2")	DL—DC Latching Solenoid

Example: A 25mm (1") P220G Series plastic electric, pressure-regulating valve with a 60 Hz solenoid, would be specified as: P220G-27-04

Operating Specifications

- Flow Range:
 - 25mm (1"): 18,9 - 132,5 LPM (5 - 35 GPM)
 - 40mm (1.5"): 113,6 - 416,4 LPM (30 - 110 GPM)
 - 50mm (2"): 302,8 - 681,4 LPM (80 - 180 GPM)
- Operating Pressure: (15,2 bar (220 psi) maximum pressure rating)
 - Electric: 0,7 - 15,2 bar (10 - 220 psi)
- Pressure regulating:
 - Outlet: 0,3 - 6,9 bar (5 - 100 psi ± 3 psi)
 - Inlet: 0,7 - 15,2 bar (10 - 220 psi)
- Minimum pressure differential (between inlet and outlet) for pressure regulation: 0,7 bar (10 psi)
- Burst pressure safety rating: 51,7 bar (750 psi)
- Body styles:
 - Globe/Angle: 25mm, 40mm, and 50mm (1", 1.5", 2") female threads
- Spike Guard™ Solenoid: 24 VAC (50/60 Hz) Standard
 - Inrush: 60 Hz; 0,12 amps
 - Holding: 60 Hz; 0,1 amps

Additional features

- Glass-filled nylon and stainless steel construction
- Internal and External bleed
- No external tubing
- Standard, built-in Schrader-type valve for downstream pressure verification
- Flow control independent of solenoid
- Self-aligning bonnet to ensure correct installation
- Self-cleaning, stainless steel metering rod
- Low-flow capability down to 5 GPM
- Low-power requirement for longer wire runs

Dimensions

- 25mm (1"): 146 x 127mm (5.75" H x 5" W)
- 40mm (1.5"): 165 x 152mm (6.5" H x 6" W)
- 50mm (2"): 191 x 178mm (7.25" H x 7" W)

Warranty

- Five years

TORO® VALVE BOXES



Learn more at
Toro.com



Features & Benefits



Specifications



Valve Boxes are used for practical, aesthetic and security reasons wherever valves or off-fairway GDC modules need to be installed below grade but remain accessible for monitoring or service. Toro offers a full line of valve boxes that will fit valves up to 10,2cm (4") and 1-, 2- and 4- station GDC modules.



TORO® VALVE BOXES

Features & Benefits

- ① **T-lip Lid Design**
The T-lip lid design keeps dirt out to prevent jamming and provides improved grip for lid removal and easy access to the equipment inside. The secure snap fit and bolt retention ensure that only authorized personnel will have access.
- ② **Wide Range Of Sizes**
Toro offers a wide range of round and rectangular boxes to meet every need. 15,2,17,8 and 25,4cm (6", 7" and 10") round; and 30,5 x 43,2cm and 38,1 x 53,3cm (12" x 17" and 15" x 21") rectangular in both 12" standard depth and 15,2cm (6") shallow depth. With the reverse stack capability and rectangular 15,2cm (6") extensions tackling deeper installations can be easily accomplished.

- ③ **Variety of Colors**
Toro valve boxes and covers come in a wide variety of colors to blend into the surrounding environment or to identify specific applications. Green for grass, tan for sand and purple for non-potable water applications. Black and brown to blend in with a variety of soils and mulches and gray for electrical applications.
- ④ **Durable Construction**
Valve boxes are constructed of H.D.P.E. (High-Density Polyethylene) with heavy-duty wall sections designed to provide a secure enclosure to protect your equipment investment.

Rectangular Extension Boxes
Rectangular extensions allow for deeper installation in 15,2cm (6") increments

Reverse Stack
Allows for deeper installations in an initial 30,5cm (12") then 70cm (24") increments.



T-Lip Lid Design

①

Wide Range of Sizes

②

Variety of Colors

③

Durable Construction

④





TORO® VALVE BOXES

Ordering Information—Round Valve Boxes

TVB-XXRND-XX		
Type	Size	Color Description
TVB	XXRND	XX
TVB—Toro Valve Box	6—15,2cm (6") Round 7—17,8cm (7") Round 10—25,4cm (10") Round	Blank—Green lid and black box G—Green lid and box GY—Gray lid and box (electrical) T—Tan lid and box E—Purple lid and box (effluent) BK—Black lid and box BR—Brown lid w/black box
Example - A Toro 17,8cm (7") round valve box for effluent water applications would be specified as: TVB-7RND-E		

Description	A Length	B Width	C Height	Weight (lbs)
15,2cm (6")	16,0cm (6.3")	20,6cm (8.1")	22,9cm (9.0")	0,52 kg (1.15 lbs)
17,8cm (7")	17,3cm (6.8")	23,6cm (9.3")	22,9cm (9.0")	0,82 kg (1.80 lbs)
25,4cm (10")	25,1cm (9.9")	33,0cm (13.0")	26,2cm (10.3")	1,54 kg (3.39 lbs)



Ordering Information—Rectangular Valve Boxes

TVB-XXXX-XX-XX			
Type	Size	Height	Color Description
TVB	XXXX	XX	XX
TVB—Toro Valve Box	1217—30,5x43,2cm (12"x17") 1521—38,1x53,3cm (15"x21")	6—15,2cm (6") High 12—30,5cm (12") High	Blank—Green lid and black box G—Green lid and box GY—Gray lid and box (elect.) T—Tan lid and box E—Purple lid and box (effluent) BK—Black lid and box BR—Brown lid w/black box
Example - A Toro 30,5x43,2x15,2(12x17x6) rectangular valve box for effluent water applications would be specified as: TVB-1217-6-E			

Description	A Length	B Width	C Height	Weight (lbs)
30,5x43,2x15,2 (12x17x6)	47,8cm (18.8")	35,0cm (13.8")	17,3cm (6.8")	2,98 kg (6.56 lbs)
30,5x43,2x30,5 (12x17x12)	53,3cm (21.0")	40,6cm (16.0")	31,2cm (12.3")	4,11 kg (9.05 lbs)
38,1x53,3x15,2 (15x21x6)	61,7cm (24.3")	47,8cm (18.8")	18,3cm (7.2")	3,97 kg (8.75 lbs)
38,1x53,3x30,5 (15x21x12)	65,3cm (25.7")	48,5cm (19.1")	31,2cm (12.3")	5,49 kg (12.11 lbs)

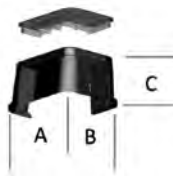

Ordering Information—Rectangular Extensions

TVB-XXXX-EXT6BOX-XX			
Type	Size	Height	Color Description
TVB	XXXX	EXT6BOX	XX
TVB—Toro Valve Box	1217—30,5x43,2cm (12"x17") 1521—38,1x53,3cm (15"x21")	EXT6BOX—15,2cm (6") High	Blank—Black box G—Green box GY—Gray box (elect.) T—Tan box E—Purple box (effluent)
Example - A Toro 15,2cm (6") extension for a 30,5x43,2cm (12"x17") tan valve box would be specified as: TVB-1217-EXT6BOX-T			

Description	A Length	B Width	C Height	Weight (lbs)
30,5x43,2x15,2 (12x17x6)	47,8cm (18.8")	35,0cm (13.8")	17,3cm (6.8")	3,04 kg (6.71 lbs)
38,1x53,3x15,2 (15x21x6)	61,7cm (24.3")	45,2cm (17.8")	17,5cm (6.9")	4,03 kg (8.89 lbs)

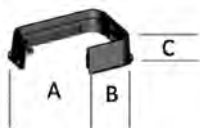

Ordering Information—Round Valve Box Separates

TVB-XXXXX-XX		
Type	Size Box or Lid	Color Description
TVB	XXXXX	XX
TVB—Toro Valve Box	6LID—15,2cm (6") Round lid 7LID—17,8cm (7") Round lid 10LID—25,4cm (10") Round lid BOX6—15,2cm (6") Box (black only) BOX7—17,8cm (7") Box (black only) BOX10—25,4cm (10") Box (black only)	G—Green lid GY—Gray lid (electrical) T—Tan lid E—Purple lid (effluent) BK—Black lid BR—Brown lid
Example - A Toro 17,8cm (7") round valve box lid for effluent water applications would be specified as: TVB-7LID-E		

Description	A Length	B Width	C Height	Weight (lbs)
15,2cm (6") lid	16,0cm (6.3")	20,6cm (8.1")	3,0cm (1.2")	0,14 kg (.31 lbs)
17,8cm (7") lid	17,3cm (6.8")	23,6cm (9.3")	4,3cm (1.7")	0,24 kg (.52 lbs)
25,4cm (10") lid	25,1cm (9.9")	33,0cm (13.0")	5,3cm (2.1")	0,51 (1.13 lbs)

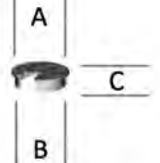

Description	A Length	B Width	C Height	Weight (lbs)
15,2cm (6") box	16,0cm (6.3")	20,6cm (8.1")	22,9cm (9.0")	0,35 kg (.77 lbs)
17,8cm (7") box	17,3cm (6.8")	23,6cm (9.3")	22,9cm (9.0")	0,54 kg (1.19 lbs)
25,4cm (10") box	25,1cm (9.9")	33,0cm (13.0")	26,2cm (10.3")	1,02 kg (2.26 lbs)

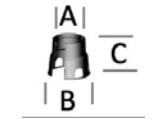

Ordering Information—Rectangular Valve Box Separates

TVB-XXXX-LID-XX			
Type	Size	Height	Color Description
TVB	XXXX	LID	XX
TVB—Toro Valve Box	1217—30,5x43,2cm (12"x17") 1521—38,1x53,3cm (15"x21")	LID—Lid	Blank—Green lid G—Green lid GY—Gray lid (elect.) T—Tan lid E—Purple lid (effluent) BK—Black lid BR—Brown lid
Example - A Toro 30,5x43,2cm (12x17) rectangular valve box lid for effluent water applications would be specified as: TVB-1217-LID-E			

TVB-XXXX-XXXXXX		
Type	Size	Height
TVB	XXXX	XX
TVB—Toro Valve Box	1217—30,5x43,2cm (12"x17") 1521—38,1x53,3cm (15"x21")	6BOX—15,2cm (6") High valve box 12BOX—30,5cm (12") High valve box
Example - A Toro 30,5x43,2x15,2(12x17x6) rectangular valve box would be specified as: TVB-1217-6BOX-BK		

Description	A Length	B Width	C Height	Weight (lbs)
30,5x43,2cm (12"x17") lid	42,9cm (16.9")	30,0cm (11.8")	5,1cm (2.0")	1,24 kg (2.73 lbs)
38,1x53,3cm (15"x21") lid	54,1cm (21.3")	37,8cm (14.9")	4,8cm (1.9")	1,47 kg (3.23 lbs)
30,5x43,2x15,2cm (12"x17"x6") box	47,8cm (18.8")	35,1cm (13.8")	17,3cm (6.8")	1,74 kg (3.83 lbs)
30,5x43,2x30,5cm (12"x17"x12") box	53,3cm (21")	40,6cm (16")	31,2cm (12.3")	2,87 kg (6.32 lbs)
38,1x53,3x15,2cm (15"x21"x6") box	61,7cm (24.3")	45,2cm (17.8")	17,5cm (6.9")	2,57 kg (5.66 lbs)
38,1x53,3x30,5cm (15"x21"x12") box	65,3cm (25.7")	48,5cm (19.1")	31,2cm (12.3")	4,02 kg (8.88 lbs)

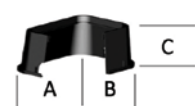



TORO® DRY BOXES

- A Dual Bolt Retention covers**
Ensures proper sealing and vandal resistance.
- B Heavy Duty Lid**
Construction molded from High Density Polyethylene (H.D.P.E), available in Green, Tan, Purple, Black, Gray and Brown.
- C Accessory Plate (optional)**
Attaches directly to the lid and allows attachments of various components like GDC modules, elec/hyd converters, battery operated controllers and more.
- D Dual Seal Lid**
Keeps water and critters from creeping in from the top.
- E Heavy Duty Box**
Construction molded from High Density Polyethylene (H.D.P.E), available in Green, Tan, Purple, Black, Gray and Brown.
- F Dirt Skirt (optional)**
Attaches directly to the bottom of the valve box and provides an outer seal to prevent intrusion from burrowing rodents, water and critters.

Specifications

Static Vertical Load Rating:
SCTE - Light Duty, Pedestrian

Properties of Base Material	ASTM Test Method	HDPE
Tensile Strength	D-638	186,16 - 303,37 bar (2700-4,400 PSI) (Typical Range)
Flexural Modulus	D-790	Minimum 14,000 not to exceed 24,000 PSI
Notched Izod Impact Strength	D-256	0.5 - 3.0 (Typical Range)
Deflection Temperature @ 66PSI	D-648	65,56 - 93,33 C (150-200 F) (Typical Range)
Density	D-792	Minimum 0.95- not to exceed 0.965
Electrical Dielectric Strength	D-149	400-600 V/mil (Typical Range)
Chemical Resistance	D-543	Very Resistant
Water Absorption	D-570	Less than 1% weight change

Warranty
• Two years

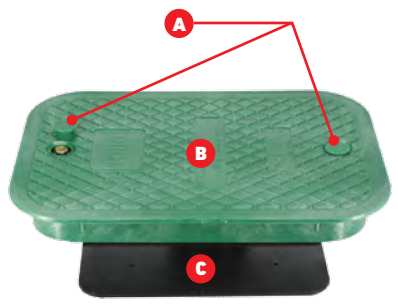

TVB-1217-DBAP (Accessory plate)



TVB-1217-DB (Dry Box)



TVB-12RND-DB (Round Dry Box)

Ordering Information—Dry Box Valve Boxes

TVB-1217-12DB-XX			
Type	Size	Height	Color Description
TVB	1217	12DB	XX
TVB—Toro Valve Box	1217—30,5X43,2 12"X17"	12DB—30,5 (12") High Dry Box	Blank— Green lid and black box G—Green lid and box GY—Gray lid and box (elect.) T—Tan lid and box E—Purple lid and box (effluent) BK—Black lid and box BR—Brown lid w/black box
Example - A Toro 30,5x43,2x30,5cm (12"x17"x12") valve box for electrical applications would be specified as: TVB-1217-12DB-GY			

Description	A Length	B Width	C Height	Weight (lbs)
12DB	53,3cm (21.0")	40,6cm (16.0")	31,2cm (12.3")	4,45 kg (9.8 lbs)

Description	A Length	B Width	C Height	Weight (lbs)
DBAP	29,2cm (11.5")	21,6cm (8.5")	0,5cm (.2")	0,45 kg (0.99 lbs)
DBDS	50,3cm (19.8")	36,8cm (14.5")	3,3cm (1.3")	1,27 kg (2.8 lbs)



Specifying Information—Dry Box Valve Boxes

TVB-12RND-DB-XX			
Type	Size	Height	Color Description
TVB	12RND	DB	XX
TVB—Toro Valve Box	30 cm (12") Round	Dry Box	G—Green GY—Gray (electrical) T—Tan E—Purple (effluent) BK—Black BR—Brown
Example: A Toro 12" round Dry Box for effluent water applications would be specified as: TVB-12RND-DB-E			

Description	A Length	B Width	C Height	Weight (lbs)
DB	29cm (11.5")	36,8cm (14.5")	32,38cm (12.75")	3,23 kg (7.12 lbs)

Accessories	
TVB-1217-DBAP	DRY BOX Accessory Plate
TVB-1217-DBDS	DRY BOX Dirt Skirt





470 QUICK COUPLER VALVES



Features

- Full range of flows from 0 to 100 gallons per minute
- 1,9, 2,5 and 3,8cm (0.75", 1" and 1.5") one- and two-piece single-lug models including ACME thread key connections to meet a variety of installation requirements
- Hose swivel provides 360° movement without hose tangling for ease of use
- A variety of sizes meet various applications
- Metal and vinyl locking and non-locking covers
- Effluent (lavender-colored) locking cover

Warranty

- Two years

Ordering Information—Quick Coupler Valve Accessories

Order Number	Description
463-01	12,7mm(0.5") Female, 19,1mm(0.75") Male, Single-lug Coupler Key
464-01	19,1mm(0.75") Female, 25,4mm(1") Male, Single-lug Coupler Key
464-02	25,4mm(1") Female, Single-lug Coupler Key
464-03	25,4mm(1") ACME Thread Coupler Key
465-01	31,8mm(1.25") Inlet, 19,1mm(0.75") Female, 25,4mm(1") Male, Single-lug Coupler Key
465-02	25,4mm(1") Female, 38,1mm(1.5") Male, Single-lug Coupler Key
466-01	31,8mm(1.25") Female, 38,1mm(1.5") Male, Single-lug Coupler Key
477-00	19,1mm(0.75") NPT x 19,1mm(0.75") MHT Hose Swivel
477-01	25,4mm(1") NPT x 19,1mm(0.75") MHT Hose Swivel
477-02	25,4mm(1") NPT x 25,4mm(1") MHT Hose Swivel
491-02	Key for Locking Cover

470 Series Friction Loss Data—(Metric)

	LPM Flow										
	35	50	75	100	125	150	175	225	275	325	375
Model 473	1,0	0,2	0,4	0,6							
Model 474			0,1	0,2	0,3	0,5					
Model 475				0,1	0,2	0,2	0,4	0,6			
Model 476						0,1	0,1	0,2	0,3	0,4	0,6

Note: For optimum sprinkler performance when designing a system, be sure to calculate total friction loss to ensure sufficient downstream pressure. Flow rates are recommended not to exceed 0,3 bar loss. Values listed in bar. For kPa values, multiply tabular values by 100. For Kg/cm² values, multiply tabular values by 1,02.

470 Series Friction Loss Data—(U.S.)

	GPM Flow											
	10	15	20	25	30	35	40	50	60	70	85	100
Model 473	1,5	3,1	5,3	8,5								
Model 474			1,1	2,2	3,6	5,7	8,0					
Model 475				1,0	1,8	2,7	3,6	6,4	9,8			
Model 476							1,0	1,7	2,6	3,6	5,6	8,8

Note: For optimum sprinkler performance when designing a system, be sure to calculate total friction loss to ensure sufficient downstream pressure. Flow rates are recommended not to exceed 5 psi loss. Values listed in psi.

Specifying Information—Quick Couplers

Toro Model Number	Description	Inlet Size NPT Threads	Body Type	Outlet Key Size	Corresponding Key(s)	Valve Cover Type	Corresponding Swivel(s)*		
							477-00	477-01	477-02
473-00	QCV 19,1(0.75), SS CVR	19,1mm(.75")	1 Piece	19,1mm(.75")	463-01	Stainless Steel	A	B	B
474-00	QCV 25,4(1), SS CVR	25,4mm(1")	1 Piece	25,4mm(1")	464-01 & 464-02	Stainless Steel	B	A	A
474-01	QCV 25,4(1), VYL CVR	25,4mm(1")	1 Piece	25,4mm(1")	464-01 & 464-02	Yellow Vinyl, Spring Loaded	B	A	A
474-03	QCV 25,4(1), VYL CVR, W/LK	25,4mm(1")	1 Piece	25,4mm(1")	464-01 & 464-02	Yellow Vinyl, Locking, Spring Loaded	B	A	A
474-04	QCV 25,4(1), LAV VYL CVR	25,4mm(1")	1 Piece	25,4mm(1")	464-01 & 464-02	Lavender Vinyl, Locking, Spring Loaded	B	A	A
474-21	QCV 25,4(1), VYL CVR, 2PC	25,4mm(1")	2 Piece	25,4mm(1")	464-01 & 464-02	Yellow Vinyl, Spring Loaded	B	A	A
474-24	QCV 25,4(1), LAV VYL CVR, 2PC	25,4mm(1")	2 Piece	25,4mm(1")	464-01 & 464-02	Lavender Vinyl, Locking, Spring Loaded	B	A	A
474-40	QCV 25,4(1), SS CVR, ACME	25,4mm(1")	1 Piece	25,4mm(1")	464-03	Stainless Steel	B	A	A
474-41	QCV 25,4(1), VYL CVR, ACME	25,4mm(1")	1 Piece	25,4mm(1")	464-03	Yellow Vinyl, Spring Loaded	B	A	A
474-44	QCV 25,4(1), LAV VYL CVR, W/LK, ACME	25,4mm(1")	1 Piece	25,4mm(1")	464-03	Lavender Vinyl, Locking, Spring Loaded	B	A	A
475-00	QCV 31,8(1.25), SS CVR	25,4mm(1")	1 Piece	31,8mm(1.25")	465-01 & 465-02	Stainless Steel	B	B	B
475-01	QCV 31,8(1.25), VYL CVR	25,4mm(1")	1 Piece	31,8mm(1.25")	465-01 & 465-02	Yellow Vinyl	B	B	B
476-00	QCV 38,1(1.5), SS CVR	38,1mm(1.5")	1 Piece	38,1mm(1.5")	466-01	Stainless Steel	B	B	B
476-01	QCV 38,1(1.5), VYL CVR	38,1mm(1.5")	1 Piece	38,1mm(1.5")	466-01	Yellow Vinyl, Spring Loaded	B	B	B
476-04	QCV 38,1(1.5), LAV VYL CVR	38,1mm(1.5")	1 Piece	38,1mm(1.5")	466-01	Lavender Vinyl, Locking, Spring Loaded	B	B	B

* A – Attaches directly to the quick coupler key. B – Requires additional fittings to be used with the quick coupler key.

VALVE SPECIFICATIONS

CONTROL SYSTEMS

Type of System	Maximum Distance From Controller to Valve	Elevation Restrictions
Pin Type [£] (00) Hydraulic* with 4,8mm (0.19") Control Tubing	30,5m (100')	
Pin Type [£] (00) Hydraulic* with 6,4mm(0.25") Control Tubing	61,0m (200')	
Normally Open (01) with 4,8mm(0.19") Control Tubing	152,4m (500')	Valve elevation should not exceed 7.6m (25') ABOVE or 21.3 (70') BELOW controller elevation.
Normally Closed (08) Hydraulic with 4,8mm(0.19") Control Tubing	152,4m (500')	Valve elevation should not exceed 0m (0') ABOVE or 21.3 (70') BELOW controller elevation.
Normally Open (01) with 6,4mm(0.25") Control Tubing	304,8m (1000')	Valve elevation should not exceed 7.6m (25') ABOVE or 21.3 (70') BELOW controller elevation.
Normally Closed (08) Hydraulic with 6,4mm(0.25") Control Tubing	304,8m (1000')	Valve elevation should not exceed 7.6m (25') ABOVE or 21.3 (70') BELOW controller elevation.
Electric (06)	Depends on variables <ul style="list-style-type: none"> • Voltage available • Wire size 	NONE

* - All hydraulic connections on Toro valves are ¹/₄" insert type.
 - Control line pressure must be equal to or greater than mainline pressure.
 - Control line pressure range is 40 to 150 psi.
 ** Minimum solenoid voltage required for reliable electric VIH operation is 19.5 V AC
 £ - Maximum of one (1) valve per station on pin type systems.

CONVERSION INFORMATION

- All gallons per minute are shown in U.S.
- To convert to imperial gallons per minute, multiply by 0.833
- To convert to liters per minute, multiply by 3.78
- To convert pounds per square inch (psi) to atmospheres, divide by 14.7
- To convert pounds per square inch (psi) to kilograms per square centimeter (kg/cm²), divide by 14.22
- To convert feet to meters, divide by 3.28

WINTERIZING SPECIFICATIONS

In freezing climates, valves should be properly winterized to prevent freeze-related damage.

SPRINKLER SPACING

The Toro Company does not recommend designing for zero (0) mph wind conditions.

■ Square Spacing

- No wind - 55% of diameter
- 4 mph wind - 50% of diameter
- 6,4 kph wind - 50% of diameter
- 8 mph wind - 45% of diameter
- 12,8 kph - 45% of diameter

■ Triangular Spacing

- No wind - 60% of diameter
- 4 mph wind - 55% of diameter
- 6,4 kph wind - 55% of diameter
- 8 mph wind - 50% of diameter
- 12,8 kph - 50% of diameter

■ Single Row Spacing

- No wind - 50% of diameter
- 4 mph wind - 50% of diameter
- 6,4 kph wind - 50% of diameter
- 8 mph wind - 45% of diameter
- 12,8 kph - 45% of diameter

Design in consideration of the worst wind conditions.

PRECIPITATION RATE FORMULAS

■ Square-spaced sprinklers in pattern:

$$\frac{\text{GPM of full-circle} \times 96.3}{(\text{Spacing})^2}$$

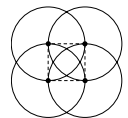

■ Triangular-spaced sprinklers in pattern:

$$\frac{\text{GPM of full-circle} \times 96.3}{(\text{Spacing})^2 (0.866)}$$



■ Area and flow:

$$\frac{\text{Total GPM of zone} \times 96.3}{\text{Total irrigated square feet of zone}}$$

■ Single row:

$$\frac{\text{GPM of full-circle} \times 96.3}{(\text{Spacing}) (\text{Scallop})}$$

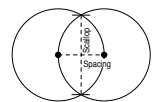

Valve-In-Head Activation Types

Electric

Pressure regulation feature at the same pressure—regardless of elevation changes
 Manual On-Off-Auto control at the sprinkler
 Individual sprinkler control for more precise watering

Normally Open

Individual sprinkler control for more precise watering
 Hydraulic control capability with sophisticated electronic/electric control systems
 Ideal for all dirty water applications—irrigation water is not used for control
 Lightning resistant

Check-O-Matic

Maintains 11,3m(37') elevation change
 Eliminates low-head drainage
 Requires separate remote control valve

Technical Data Book

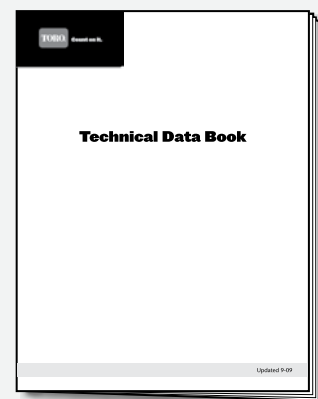

Form No. 490-1737



WIRE SIZING

Current Draw (Amperage)

Standard Wattage Solenoid

Product	Solenoids	Assumes 24 VAC, 50/60 Hz Output			
		120 VAC, 60 Hz		240 VAC, 50 Hz	
		Inrush	Holding	Inrush	Holding
Lynx VP Satellite/ Network and VPE Satellite	0	—	0.20	—	0.19
	1	0.26	0.25	0.30	0.22
	2	0.35	0.30	0.34	0.25
	3	0.40	0.34	0.36	0.28
	4	0.46	0.39	0.39	0.30
	5	0.50	0.43	0.42	0.33
	6	0.64	0.48	0.44	0.36
	7	0.70	0.52	0.46	0.38
	8	0.73	0.56	0.50	0.41
	9	0.77	0.61	0.53	0.43
	10	0.80	0.65	0.57	0.46
	11	0.85	0.69	0.57	0.48
	12	0.91	0.73	0.57	0.51
	13	1.00	0.77	0.61	0.53
	14	1.03	0.81	0.62	0.55
	15	1.05	0.85	0.63	0.58
Network LTC Satellite	0	0.15	0.15	0.14	0.14
	1	0.23	0.21	0.18	0.17
	2	0.31	0.27	0.21	0.20
	3	0.39	0.33	0.24	0.23
	4	0.47	0.39	0.26	0.25
	5	0.55	0.45	0.29	0.28
	6	0.63	0.51	0.32	0.30
	7	0.71	0.57	0.34	0.33
	8	0.79	0.63	0.37	0.35
	9	0.87	0.69	0.40	0.38
	10	0.95	0.75	0.42	0.40
	11	1.03	0.81	0.45	0.43
E-Series OSMAC Satellite	0	0.05	0.05	0.03	0.03
	1	0.13	0.11	0.07	0.06
	2	0.21	0.17	0.12	0.09
	3	0.29	0.23	0.17	0.12
	4	0.37	0.29	0.21	0.15
	5	0.45	0.35	0.26	0.19
	6	0.53	0.41	0.31	0.22
	7	0.61	0.47	0.35	0.25
	8	0.69	0.53	0.40	0.28
	9	0.77	0.59	0.45	0.31
	10	0.85	0.65	0.50	0.35
	11	0.93	0.71	0.54	0.38
	12	1.01	0.77	0.59	0.41
	13	1.09	0.83	0.64	0.44
	14	1.17	0.89	0.68	0.47
	15	1.25	0.95	0.73	0.51
16	1.33	1.01	0.81	0.54	

Spike Guard™ Low Wattage Solenoid

Product	Solenoids	Assumes 24 VAC, 50/60 Hz Output			
		120 VAC, 60 Hz		240 VAC, 50 Hz	
		Inrush	Holding	Inrush	Holding
Lynx VP Satellite/ Network and VPE Satellite	0	—	0.20	0.21	0.20
	1	0.24	0.22	0.22	0.21
	2	0.26	0.24	0.23	0.22
	3	0.29	0.27	0.24	0.23
	4	0.31	0.29	0.25	0.24
	5	0.33	0.31	0.26	0.26
	6	0.35	0.33	0.28	0.27
	7	0.39	0.37	0.29	0.28
	8	0.41	0.39	0.30	0.30
	9	0.43	0.41	0.32	0.31
	10	0.46	0.44	0.34	0.33
	11	0.47	0.46	0.35	0.35
	12	0.49	0.48	0.36	0.36
	13	0.52	0.50	0.37	0.38
	14	0.54	0.52	0.38	0.39
	15	0.56	0.54	0.40	0.40
	16	0.58	0.56	0.43	0.42
	17	0.60	0.58	0.44	0.43
	18	0.61	0.60	0.46	0.45
	19	0.63	0.62	0.47	0.46
	20	0.66	0.64	0.49	0.48
	21	0.68	0.66	0.50	0.49
	22	0.70	0.68	0.51	0.50
	23	0.74	0.70	0.53	0.52
	24	0.76	0.72	0.54	0.53
	25	0.79	0.74	0.55	0.54
	26	0.80	0.75	0.57	0.56
	27	0.85	0.77	0.58	0.57
	28	0.90	0.79	0.59	0.58
	29	0.93	0.81	0.60	0.59
	30	0.96	0.82	0.61	0.60
	31	1.01	0.84	0.62	0.61
32	1.04	0.86	0.64	0.62	
Network LTC Satellite and Network LTC Plus Satellite	0	0.15	0.15	0.14	0.14
	1	0.17	0.17	0.16	0.15
	2	0.20	0.19	0.18	0.17
	3	0.22	0.21	0.20	0.19
	4	0.25	0.23	0.21	0.20
	5	0.27	0.25	0.23	0.22
	6	0.29	0.27	0.25	0.24
	7	0.32	0.29	0.27	0.25
	8	0.34	0.31	0.28	0.27
	9	0.37	0.33	0.30	0.29
	10	0.39	0.35	0.32	0.30
	11	0.41	0.37	0.33	0.31
12	0.44	0.39	0.34	0.33	
E-OSMAC Satellite	0	0.05	0.05	0.03	0.03
	1	0.07	0.07	0.05	0.05
	2	0.10	0.09	0.06	0.06
	3	0.12	0.11	0.08	0.08
	4	0.15	0.13	0.10	0.09
	5	0.17	0.15	0.12	0.11
	6	0.19	0.17	0.13	0.12
	7	0.22	0.19	0.15	0.14
	8	0.24	0.21	0.17	0.15
	9	0.27	0.23	0.18	0.17
	10	0.29	0.25	0.20	0.18
	11	0.31	0.27	0.22	0.20
	12	0.34	0.29	0.23	0.21
	13	0.36	0.31	0.25	0.23
	14	0.39	0.33	0.27	0.24
	15	0.41	0.35	0.29	0.26
16	0.44	0.37	0.30	0.27	





THE TORO LIMITED WARRANTY

for Golf Irrigation Equipment

The Toro Company and its affiliate, Toro Warranty Company, pursuant to an agreement between them, jointly warrants to the owner, each new piece of irrigation equipment (featured in the current catalog at date of installation) against defects in material and workmanship for a period described below, provided they are used for irrigation purposes under manufacturer's recommended specifications.

During the warranty period, we will repair or replace, at our option, any part found to be defective. Your remedy is limited solely to the replacement or repair of defective parts.

This warranty does not apply (i) to Acts of God (e.g., lightning, flooding, etc.); or (ii) to products not manufactured by Toro when used in conjunction with Toro products; or (iii) where equipment is used, or installation is performed in any manner contrary to Toro's specifications and instructions, nor where equipment is altered or modified.

Return the defective part to your irrigation contractor or installer, or your local Golf Irrigation Distributor,

or contact The Toro Warranty Company, P.O. Box 489, Riverside, California 92502, (800) 664-4740 for the location of your nearest Toro distributor or outside the U.S., call +1 (951) 688-9221.

Neither Toro nor Toro Warranty Company is liable for indirect, incidental or consequential damages in connection with the use of equipment, including but not limited to: vegetation loss, the cost of substitute equipment or services required during periods of malfunction or resulting non-use, property damage or personal injury resulting from installer's actions, whether negligent or otherwise.

Some states do not allow the exclusion of incidental or consequential damages, so the above exclusion may not apply to you.

All implied warranties, including those of merchantability and fitness for use, are limited to the duration of this express warranty.

Some states do not allow limitations on how long an implied warranty lasts, so the above limitation may not apply to you.

This warranty gives you specific legal rights and you may have other rights which vary from state to state.

Golf Sprinklers

All Toro golf sprinklers are covered by this warranty for two (2) years from date the date of installation. Proof of installation date required for any warranty claim. If the Golf Sprinklers are installed with Toro Swing Joints, the warranty is extended to 5 years.

Valves

220G Series, P-220G Series, and 470 Series quick coupler valves are covered by this warranty for two (2) years from date of installation.

DL2000 Subsurface Drip Irrigation

Toro DL2000 Subsurface Drip Irrigation products are covered by this warranty for two (2) years from date of installation.

Control Systems and Turf Guard®

All Toro golf control systems (central controls, field satellite controllers, GDC and Turf Guard), unless covered by a Toro NSN Support Plan, are covered by this warranty for one (1) year from date of installation.



We reserve the right to improve our products and make changes in the specifications and designs without notice and without incurring obligation. Products depicted in this brochure are for demonstration purposes only. Actual products offered for sale may vary in design and features.



Toro is always there to help you care for your landscapes the way you want, when you want, better than anyone else.



toro.com

Worldwide Headquarters
The Toro Company
8111 Lyndale Ave. So.
Bloomington, MN 55420 U.S.A.
Phone: (1) 952 888 8801
Fax: (1) 952 887 8258

Printed in U.S.A.
©2015 The Toro Company.
All Rights Reserved.

GB 200-XXXX Electronic Only

Count on it.



facebook.com
twitter.com/TheToroCompany
youtube.com/ToroCompanyEurope

Join the conversation
@ToroGolf

Products depicted in this literature are for demonstration purposes only. Actual products offered for sale may vary in use, design, required attachments and safety features. We reserve the right to improve our products and make changes in specifications, design and standard equipment without notice and without incurring obligation. See your dealer for details on all our warranties.